

## READ COMPLETE INSTALLATION INSTRUCTIONS AND TEMPLATE BEFORE STARTING.

Attention Installer: **WARNING** This product must be installed by a qualified heating and air conditioning contractor. Failure to do so could result in serious injury from electrical shock.

### WARNING

- 120 volts may cause serious injury from electrical shock. Disconnect electrical power to the furnace before starting installation.
- Sharp edges may cause serious injury from cuts. Use care when cutting plenum openings and handling ductwork.

### CAUTION

- Do not set humidity higher than recommended. Condensation damage may result.
- Do not set humidity up to recommended levels if there is condensation on the inside of windows of any unheated living space. Condensation damage may result.
- Do not mount Humidifier Control on supply plenum or duct. The unit will not withstand supply temperatures.
- When installing Humidifier Control on downflow furnaces, ensure blower continues to run after a heat call is satisfied to eliminate high temperatures from damaging the Humidifier Control.
- Do not mount Humidifier Control downstream of the bypass outlet. False humidity conditions will cause humidifier to operate incorrectly.

THESE INSTALLATION INSTRUCTIONS ARE FOR THE APRILAIRE HUMIDIFIER CONTROL ONLY!  
For Aprilaire® Humidifier installation, follow Aprilaire Humidifier Installation Instructions.

### STEP 1: Unpack the Humidifier Control Carton

Make sure all components are present (see Figure A):

- |                               |                              |
|-------------------------------|------------------------------|
| A. Humidifier Control         | C. Manual Mode Label         |
| B. Outdoor Temperature Sensor | D. Manual Mode Resistor Case |

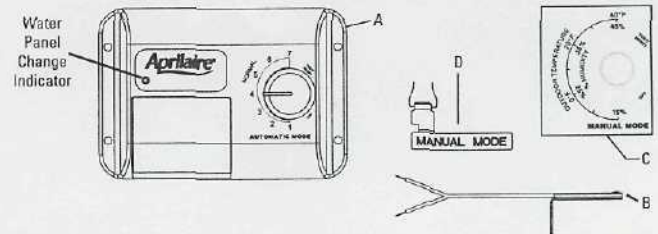

Figure A

### STEP 2: Disassemble the Humidifier Control

Remove door from the Humidifier Control by pulling the bottom of the door straight out.

### STEP 3: Check the Mode Switch

With the door removed, notice the switch labeled BYPASS and POWER (partially covered by the enclosure). Make sure the switch is correctly set for the type of humidifier being installed.

POWER HUMIDIFIERS: 110, 112, 445, 448, 760, 700 (formerly 768)  
BYPASS HUMIDIFIERS: 220, 224, 400, 440, 550, 558, 560, 568, 600

### STEP 4: Check the Change Water Panel indicator setting.

This setting will control when the indicator light turns on, reminding you to change your Water Panel. If your Control came with a humidifier, the Control is pre-set. If the installation site has a 3-month or shorter heating season or very hard water, you may want to adjust the setting. (see Figure B). The Control must be energized to reset the Water Panel Indicator.

Use the "OFF" setting to turn the Water Panel Change indicator OFF

Use setting "A" for Model 400 humidifiers. Humidifier Controls that come with a Model 400 humidifier will be pre-set to setting "A"

Use setting "B" for Model 600 and 700 humidifiers when the heating season is 3 months or less or the area has very hard water

Use setting "C" for Model 600 and 700 humidifiers when the heating season is longer than 3 months. Humidifier Controls that come with a Model 600 or 700 humidifier will be pre-set to setting "C"

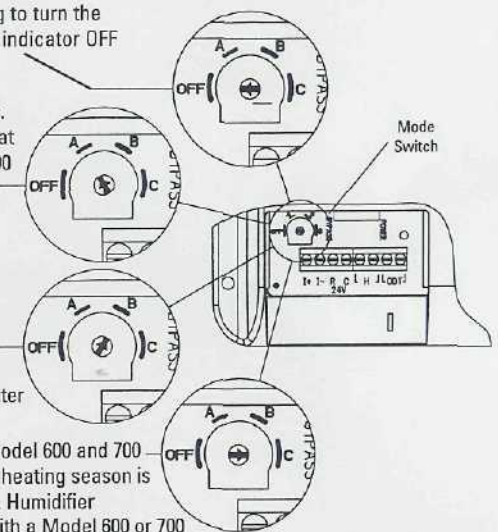

Figure B

### STEP 5: Determine Location for Humidifier Control and Mount It

Humidifier Control must be mounted in the Return Duct. For proper operation, the Humidifier Control must be at least 6 inches upstream of any of the following:

- Humidifier
- Humidifier Bypass Ductwork (if applicable)
- Fresh Air Intake Ductwork (if applicable) (see Figure C)

After location for Control is selected, use the perforated Humidifier Control template (attached to these instructions) to mark the duct opening and cut it. Use 4 sheet metal screws (not provided) to mount the Humidifier Control in the duct opening and make sure Humidifier Control is sealed tightly to duct.

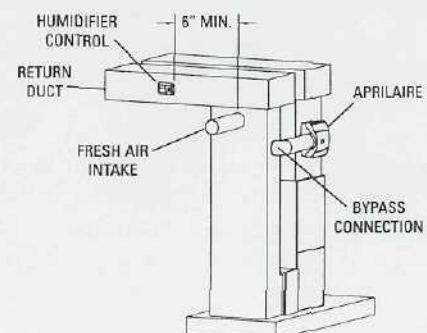

Figure C

## STEP 6: Determine Location for Outdoor Temperature Sensor

The location of the Outdoor Temperature Sensor must meet these three requirements:

1. Must be mounted on North, East or West side of house out of direct sunlight
2. Must be at least 3 feet from all exhaust vents
3. Must be above expected snow line (See figure D)

*Incorrect humidity levels will result if these requirements are not met.*

## STEP 7: Locate Existing Access Hole to Outside

A convenient way to get the Sensor wire outside is to make use of unused wires running to the A/C condensing unit (if applicable). Other ways are to use existing holes for Cable TV lines, telephone lines, A/C lines, etc. Read all equipment instructions beforehand for possible conflicts and warnings.

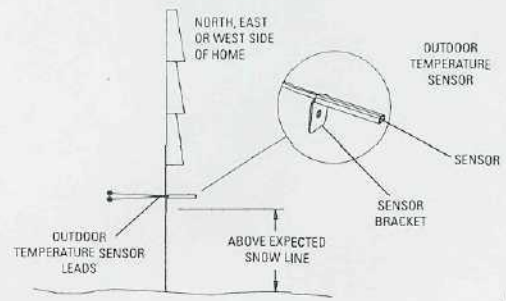

Figure D

## STEP 8: Alternate Location for Outdoor Temperature Sensor

The Sensor can also be mounted in the center of either:

- 2 inch PVC fresh air intake pipe for the furnace
- OR
- 6 inch fresh air intake duct. Mount the sensor with a #8 galvanized screw.

In both cases, the Sensor must be no more than 3 feet from the outside wall.

See Figure E.

If it is not feasible to use the Outdoor Temperature Sensor in any of the ways described, the Humidifier Control can be installed for Manual Operation.

See box below and Figure G for details.

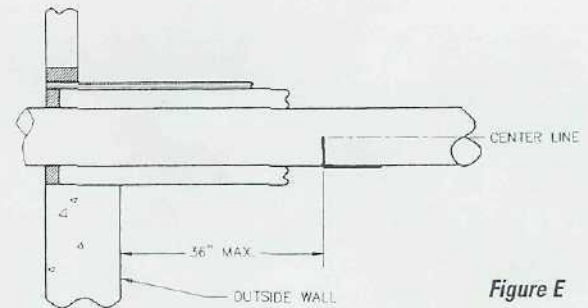

Figure E

## STEP 9: Route the Wire to Chosen Sensor Location

Run wire to the outdoor temperature sensor. Sensor is not affected by lead length. In either case, do not run outdoor temperature sensor alongside wires carrying high voltage (120 VAC or higher). Attach the sensor bracket to the house with a #8 galvanized screw

## STEP 10: Attach Sensor Wire to Humidifier Control

Strip wire 1/4 inch, and insert the wires from the Sensor into the terminals labeled "ODT" on the Humidifier Control. See Figure F for location of terminals.

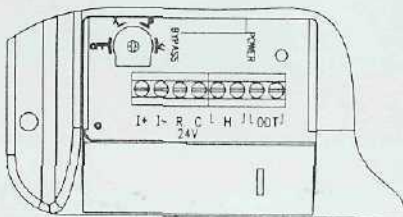

Figure F

## Installing the Humidifier Control for Manual Operation

If it is not feasible to use the Outdoor Temperature Sensor, the Humidifier Control can be installed in Manual Mode.

1. Insert the Manual Mode Resistor Case into the terminals labeled "ODT" on the Humidifier Control.
2. Snap the Manual Mode Resistor Case into the slot provided so that Resistor Case sticks out from the bottom edge of the base.
3. Remove the control knob and apply the Manual Mode label to the cover, aligning the sticker and knob holes. Re-install the knob.

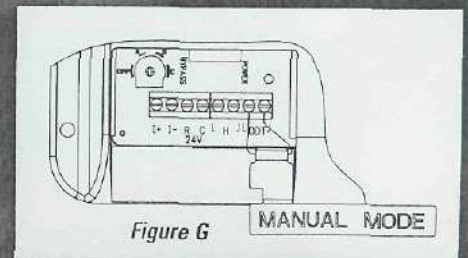

Figure G

## STEP 11: Determine Power Source for Humidifier Control

Determine where you will get 24 VAC to power the Humidifier Control based on the 2 options below:

**OPTION 1: FURNACES WITH ACCESSORY TERMINALS.** If the accessory terminals provide:

- 24 VAC, wire these directly to the "R" and "C" terminals on the Humidifier Control.
- 120 VAC, wire to a 24 VAC transformer, which in turn would connect to the "R" and "C" terminals on the Humidifier Control.

*In either case, the voltage to the Humidifier Control must be between 22 VAC – 30 VAC.*

**OPTION 2: EXTERNAL 24 VAC TRANSFORMER:** Wire into a power source other than the furnace blower circuit. The transformer can be powered off the 120 VAC line at the junction box before it enters the furnace. The 24 volt side of the transformer is connected to the "R" and "C" terminals on the Humidifier Control.

- NOTES:**
- The Humidifier Control will operate properly with either a switched or continuous power source.
  - Whether using ACCESSORY TERMINALS OR an EXTERNAL TRANSFORMER, the minimum VA required is: 2.0 VA for Power Humidifiers (Models 110, 112, 445, 448, 700, 760, 768); or 10.0 VA for Bypass Humidifiers (Models 220, 224, 400, 440, 550, 558, 560, 568, 600)
  - When power is connected for the first time the red and green LEDs will light momentarily.

## STEP 12: Humidifier Wiring

Strip the wires used for all the Humidifier Control terminal connections 1/4 inch.

- If FURNACE ACCESSORY TERMINALS are used, wire the solenoid valve in series with the "H" terminals on the Humidifier Control without using a Model 50 Relay. See furnace manual for operation of accessory terminals. (Figure H)
- If an EXTERNAL TRANSFORMER is used, a Model 50 Current Sensing Relay must be connected to the solenoid valve and the "H" terminals on the Humidifier Control to allow the humidifier to operate only when the blower is on. (Figure I)  
Wire the Model 50 Relay into the "H" circuit only.

Bypass and Power units are wired to the AHC in the same fashion.

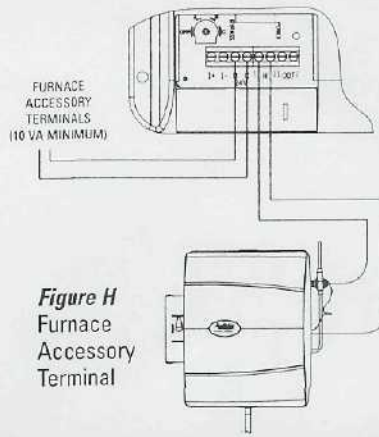

Figure H  
Furnace  
Accessory  
Terminal

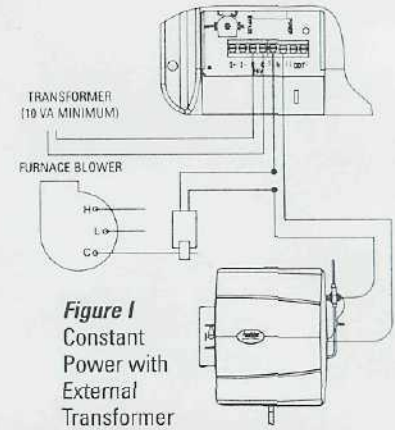

Figure I  
Constant  
Power with  
External  
Transformer

### System Checkout

1. For system Test/Reset, be sure that 24 VAC is applied to the "R" and "C" terminals of Humidifier Control.
2. Snap the door back onto the Humidifier Control Base.
3. Activate furnace blower and be sure thermostat is calling for heat.
4. Rotate the control knob of Humidifier Control clockwise to the "Test/Reset" position. When the knob is set in the "Test/Reset" position, the green "Change Water Panel" light will blink. Make sure the knob is not left in the "Test/Reset" position when the installation is done. Rotating knob to test position resets the water panel change timer to zero. The Control must be energized to reset the Water Panel Indicator.
5. If all is set up properly, you should be able to hear the solenoid valve click open. In "Test/Reset" mode, the Aprilaire Humidifier will operate for 1 minute.
6. If the humidifier does not activate with the Humidifier Control in the "Test/Reset" position, refer to troubleshooting guide.
7. Setting the Humidifier Control:
  - If home is occupied, set Humidifier Control to "Normal" (For Manual Operation, set to 35%)
  - If home is vacant, set Humidifier Control to "Off"
8. Inform homeowner to refer to the Aprilaire Owner's Manual for the initial adjustment period.
9. Make sure the Red Diagnostic Light is not lit. If the Red Diagnostic Light is lit, re-check your wiring. If the Red Diagnostic Light does not go off, replace the Humidifier Control with a new unit.

## Humidifier Control Troubleshooting Guide

Applies to both Automatic and Manual Operation unless indicated otherwise.

SYMPTOM	TROUBLESHOOTING PROCEDURE
Humidifier does not operate in "Test" mode	<ul style="list-style-type: none"> <li>• Make sure furnace blower is operating and thermostat is calling for heat.</li> <li>• Make sure the Outdoor Temperature Sensor is connected to the "ODT" terminals of the control. (For Manual Operation, make sure Manual Mode Resistor Case is in place of the Sensor).</li> <li>• Check main wiring diagram for correct Humidifier Control installation.</li> <li>• If connected to a Model 400 Humidifier, make sure both floats in the bottom of the scale control insert are in the down position. If necessary, dump out water to lower floats.</li> <li>• Check voltage at Humidifier Control "R" and "C" terminals. Voltage should be 22 VAC minimum – 30 VAC maximum.</li> <li>• Check Model 50 Current Sensing Relay (if used) for correct installation (see Model 50 instructions). Do not use Model 50 Relay in transformer circuit or "R" and "C" circuit of Humidifier Control. Model 50 relay is to be used in the "H" circuit only.</li> <li>• In "Test" mode, humidifier will operate for 1 minute only. DO NOT LEAVE IN TEST MODE AS HUMIDIFIER WILL NOT OPERATE</li> <li>• Make sure saddle valve is open.</li> </ul>
"Change Water Panel" Indicator is lit.	<ul style="list-style-type: none"> <li>• Call your installer to have your Water Panel changed, or visit your installer to purchase a new Aprilaire Water Panel. Follow the instructions on the Water Panel box.</li> </ul>

### PERFORATED HUMIDIFIER CONTROL TEMPLATE

#### WARNING

Sharp edges on the opening may cause cuts. Use care when cutting the plenum opening and installing the Humidifier Control.

#### CAUTION

- Do not mount Humidifier Control on supply plenum or duct. The unit will not withstand supply temperatures and will malfunction!
- When installing Humidifier Control on counterflow furnaces, ensure blower continues to run after a heat call is satisfied to eliminate high temperatures from damaging the Humidifier Control.
- Do not mount Humidifier Control downstream of the bypass outlet. False humidity conditions will cause humidifier to operate incorrectly.

1. TEAR OUT TEMPLATE ALONG PERFORATED EDGES.
2. PLACE THIS TEMPLATE ON THE RETURN PLENUM UPSTREAM OF (BEFORE) THE HUMIDIFIER CONNECTION.
3. TRACE THE OUTSIDE EDGES OF THIS TEMPLATE.
4. REMOVE TEMPLATE AND ACCURATELY CUT THE PLENUM OPENING.
5. USING 4 SHEET METAL SCREWS, INSTALL HUMIDIFIER CONTROL IN PLENUM OPENING.

# Humidifier Control Troubleshooting Guide

Applies to both Automatic and Manual Operation unless indicated otherwise.

## SYMPTOM

## TROUBLESHOOTING PROCEDURE

Humidifier operates only in "Test" mode

- If outdoor temperature is greater than 60°F or less than -30°F, the Humidifier Control will only operate in the "Test" mode. (Automatic Mode Only)
- If the humidity level in the home is higher than the knob setting, the Humidifier Control will not operate the Humidifier.
- Check the resistance of the sensor by removing the leads of the Outdoor Temperature Sensor from the terminals and measuring the resistance across the wires with an ohmmeter. Confirm reading to outdoor temperature in Table 1. (For Manual Operation, verify that resistance across the leads of Manual Mode Resistor Case is between 44,000 and 48,000 ohms).
- Make sure the Outdoor Temperature Sensor is mounted completely outside the house on the North, East, or West side of the house and out of direct sunlight. (Automatic Mode Only)
- If Outdoor Temperature Sensor is mounted in fresh air intake duct, make sure the probe is no more than 36 inches from the outside wall. (Automatic Mode Only)
- Make sure the Outdoor Temperature Sensor is located at least 3 feet away from all exhaust vents. (Automatic Mode Only)

TABLE 1

Outdoor Temperature	Resistance kΩ
-30°F	230.6
-20°F	163.8
-10°F	117.6
0°F	85.4
10°F	62.6
20°F	46.3
30°F	34.6
40°F	26.1
50°F	19.9
60°F	15.3
70°F	11.9
80°F	9.4
90°F	7.4
100°F	5.9

Humidifier operates constantly

- If the humidity level in the home is less than the knob setting, the Humidifier Control will operate the Humidifier until the humidity level is higher than the knob setting.
- In the "Test" mode, verify unit will operate for approximately one minute.
- Check the resistance of the sensor by removing the wires of the Outdoor Temperature Sensor and measuring the resistance across the wires with an ohmmeter. Confirm reading to outdoor temperature in Table 1. (For Manual Operation, verify that resistance across the leads of Resistor Case is between 44,000 and 48,000 ohms.)
- Make sure the Outdoor Temperature Sensor is mounted completely outside the house on the North, East, or West side of the house and out of direct sunlight. (Automatic Mode Only).
- Rotate the Humidifier Control knob counterclockwise to the "Off" position, and observe whether the humidifier turns off. If the humidifier still operates in the "Off" position, perform the following:
  1. Check summary wiring diagram for correct Humidifier Control Installation.
  2. Remove wires from Humidifier Control's "H" terminals. If Humidifier continues to operate, replace solenoid valve.

TABLE 1

Outdoor Temperature	Resistance kΩ
-30°F	230.6
-20°F	163.8
-10°F	117.6
0°F	85.4
10°F	62.6
20°F	46.3
30°F	34.6
40°F	26.1
50°F	19.9
60°F	15.3
70°F	11.9
80°F	9.4
90°F	7.4
100°F	5.9

Humidifier or Humidifier Control "chatters" or clicks ON and OFF rapidly

- Check for steady 22 VAC – 30 VAC with voltmeter.
- Make sure Outdoor Temperature Sensor wiring is not run alongside wires carrying high voltage (120 VAC or higher). (Automatic Only)

Red Diagnostic Light is on

- Check that the wiring is correct.
- Measure the resistance of the Outdoor Temperature Sensor by removing the leads from the terminal and measuring the resistance across the wires with an ohmmeter. Confirm the reading with the temperature in Table 1. (For Manual Operation, verify that the resistance across the leads of the Manual Mode Resistor Case is between 44,000 and 48,000 ohms).

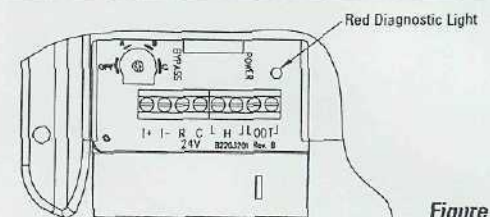

Figure J

**IRP** RESEARCH PRODUCTS CORPORATION

P.O. BOX 1467 • MADISON, WI 53701-1467  
Call 608/257-8801 • FAX 608/257-4357