

HEAT CONTROLLER, INC.

INSTALLATION, OPERATION & MAINTENANCE MANUAL

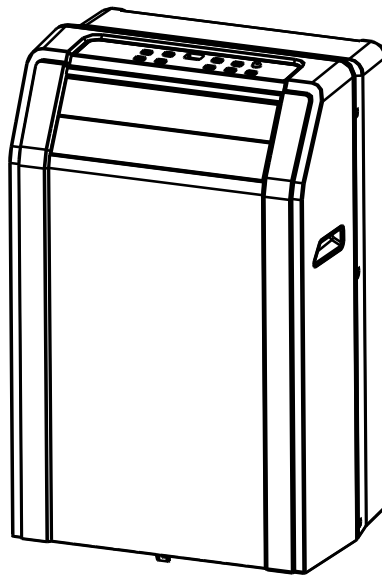

Portable Room Air Conditioner

PS-81A

PS-101A

PS-121A

French version of this manual is available on our website

TABLE OF CONTENTS

SAFETY PRECAUTIONS

Safety rules.....3
Operating conditions.....3
Electrical information4

IDENTIFICATION OF PARTS

Accessories4
Identification of parts5

AIR CONDITIONER FEATURES

Electronic control operating instructions.....6

OPERATING INSTRUCTIONS

Operating instructions.....8

INSTALLATION INSTRUCTIONS

Location9
Window slider kit installation.....9
Exhaust hose installation.....12
Condensate drainage13

CARE AND MAINTENANCE

Care and maintenance14

TROUBLESHOOTING TIPS

Trouble shooting15

SAFETY PRECAUTIONS

Safety rules

To prevent injury to the user or other people and property damage, the following instructions must be followed. Incorrect operation due to ignoring the instructions may cause harm or damage.

Always do this

- Your air conditioner should be used in such a way that it is protected from moisture. e.g. condensation, splashed water, etc. Do not place or store your air conditioner where it can fall or be pulled into water or any other liquid. Unplug immediately if water enters unit.
- Always transport use and store your air conditioner in a vertical, upright position on a stable, level surface.
- Turn off the product when not in use.
- Always contact a qualified servicer to make repairs. If the supply cord is damaged it must be repaired by an authorized servicer.
- Keep a clearance of at least 1 ft. (30cm) around the unit, away from walls, furniture and curtains.
- If the air conditioner is knocked over during use, turn off the unit and unplug from the main power supply immediately.

Never do this

- Do not operate your air conditioner in a damp/humid room such as a bathroom or laundry room.
- Do not touch the unit with wet or damp hands or to avoid electrical shock.
- Do not remove any cover panels.
- Never use this appliance if it is not working properly, or if it has been dropped or damaged.
- Never use the plug to start and stop the unit. Always use the switch on the control panel.
- Do not cover or obstruct the inlet or outlet grilles.
- Do not use hazardous chemicals to clean or allow them to come into contact with the unit.
- Do not use the unit in the presence of inflammable substances or vapors such as alcohol, insecticides, gasoline, etc.
- Do not use this product for functions other than those described in this instruction manual.

Save Energy

- Use the unit in the recommended room size - see carton.
- Locate the unit where furniture or other objects cannot obstruct the air flow.
- Keep blinds/curtains closed during the sunniest part of the day.
- Keep the filters clean.
- Keep doors and windows closed to keep cool air in and warm air out.

Operating conditions

- The air conditioner must be operated within the temperature range indicated below:

MODE	ROOM TEMPERATURE
COOL	62-95°F (17-35°C)
DRY	55-95°F (13-35°C)

Suggested tools for window kit installation

1. Screwdriver (medium size Phillips)
2. Tape measure or ruler
3. Knife or scissors
4. Saw (In the event that the window kit needs to be cut down in size because the window is too narrow for direct installation)

IDENTIFICATION OF PARTS

▲ WARNING For your safety

- Do not store or use gasoline or other flammable substances/vapors in the vicinity of this or any other appliance.
- To avoid fire hazard or electric shock, do not use an extension cord or an adaptor plug. Do not remove any prong from the power cord.

▲ WARNING Electrical Information

- Be sure the electrical service is adequate for the model you have chosen. This information can be found on the name/rating plate, which is located on the side of the cabinet and behind the grille.
- To minimize shock and fire hazards, proper grounding is important. Your air conditioner must be used in a properly grounded wall receptacle. If the wall receptacle you intend to use is not adequately grounded or protected by a time delay fuse or circuit breaker, have a qualified electrician install the proper receptacle.

Accessories

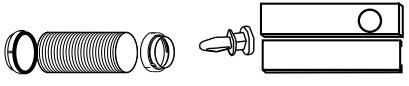
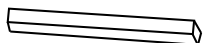
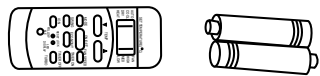
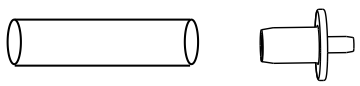
PARTS :	PARTS NAME :
	Exhaust hose and Apaptor Window Slider Kit and bolt
	Foam seal
	Remote Controller and Batteries
	Drain hose and drain hose adaptor

- Check all the accessories are included in the package and please refer to the installation instructions for their usage.

NOTE: *All the illustrations in this manual are for explanation purposes only. Your air conditioner may be slightly different. The actual shape of parts, accessories, unit, etc. shall prevail.*

IDENTIFICATION OF PARTS

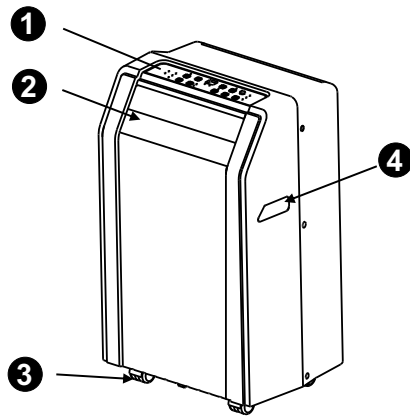

Fig.1

Front

- ① Control Panel
- ② Horizontal Louver Blade (swings automatically)
- ③ Casters
- ④ Carrying Handles (both sides)

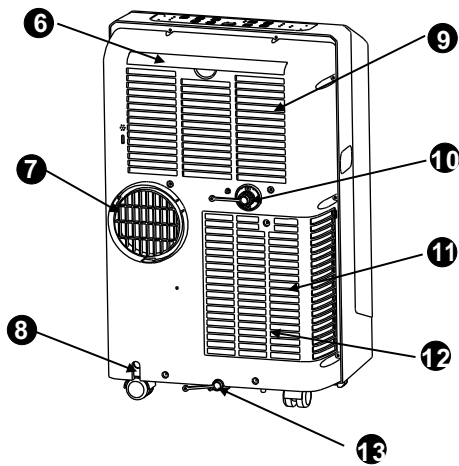

Fig.2

Rear

- ⑥ Upper Air Filter (Behind the grille)
- ⑦ Air Outlet
- ⑧ Power cord outlet
- ⑨ Air intake
- ⑩ Drain Outlet
- ⑪ Air intake
- ⑫ Lower Air Filter (Behind the grille)
- ⑬ Bottom tray drain outlet

AIR CONDITIONER FEATURES

ELECTRONIC CONTROL OPERATING INSTRUCTIONS

Before you begin, thoroughly familiarize yourself with the functions control panel and remote controller.

The unit can be controlled by the unit control panel alone or with the remote controller .

NOTE: This manual does not include Remote Controller Operations, see the <<Remote Controller Instruction>> packed with the unit for details.

OPERATION PANEL OF THE AIR CONDITIONER

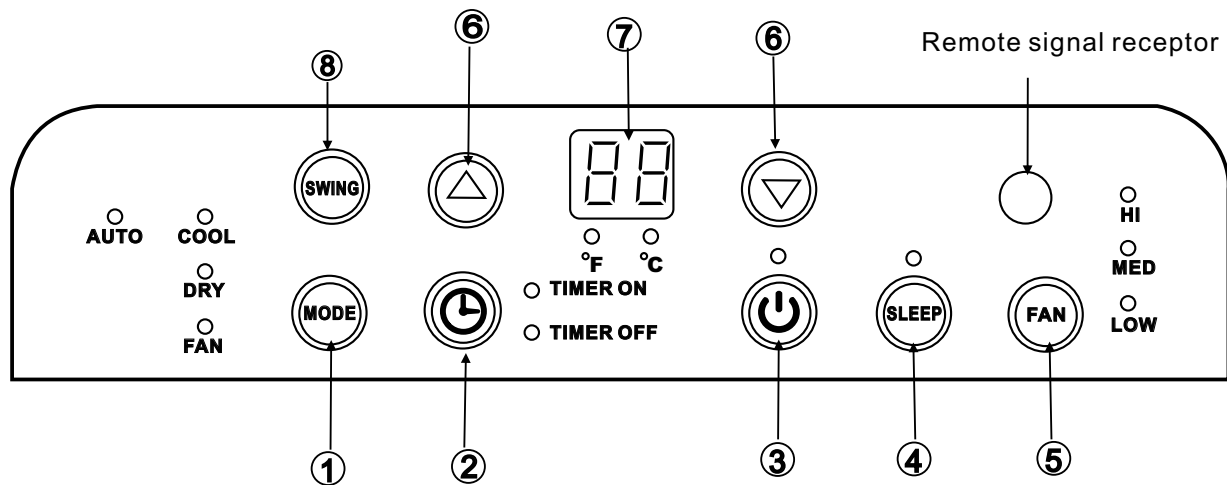

Fig.3

① MODE select button

Selects the appropriate operating mode. Each time you press the button, a mode is selected in a sequence that goes from AUTO, COOL, DRY, and FAN. The mode indicator light illuminates under the selected mode settings Fig.3.

② TIMER button

Used to initiate the AUTO ON start time and AUTO OFF stop time program, in conjunction with the Δ and ∇ buttons.

③ POWER button

Power switch on/off.

④ SLEEP button

Used to initiate the SLEEP operation.

⑤ FAN button

Controls the fan speed. Each time the fan button is pressed, a different fan speed is selected in a sequence as follows: LOW, MED, HI and AUTO. When AUTO mode is selected, all of the fan indicator lights turn off.

⑥ UP(Δ) and DOWN(∇) button

Used to adjust (increasing/decreasing) temperature settings(2°F/1°C increments) in a range of (62°F)17°C to (88°F)30°C or the TIMER setting in a range of 0~24hrs.

NOTE: The control is capable of displaying temperature in degrees Fahrenheit or degrees Celsius. To convert from one to the other, press and hold the Up and Down buttons at the same time, for 3 seconds.

⑦ LED Display

Shows the set temperature in " °C" or " °F" and the Auto-timer settings. While in DRY or FAN modes, it displays the room temperature.

Error codes and protection code:

- E1-** Room temperature sensor error- Unplug the unit and plug it back in. If error repeats, call for service.
- E2-** Evaporator temperature sensor error- Unplug the unit and plug it back in. If error repeats, call for service.
- E4-** Display panel communication error- Unplug the unit and plug it back in. If error repeats, call for service.
- P1-** Bottom tray is full - Connect the drain hose and drain the collected water away. If error repeats, call for service.

OPERATING INSTRUCTIONS

⑧ SWING button

Used to initiate the automatic swing function. When the swing mode is on, press the swing button to stop the lover at the desired angle. Pressing and holding the button can restart the auto swing function.

Operating Instructions

COOL operation

- Press the "MODE" button until the "COOL" indicator light comes on.
- Press the ADJUST buttons "▲" or "▼" to select the desired room temperature.
- Press the "FAN SPEED" button to select the desired fan speed.

DRY operation

- Press the "MODE" button until the "DRY" indicator light comes on.
- Under this mode, you cannot change the fan speed or adjust the temperature. The fan motor operates at LOW speed automatically.
- Keep windows and doors closed for the best dehumidifying effect.
- Do not connect the duct to window.

AUTO operation

- When you set the air conditioner in AUTO mode, it will automatically select cooling, or fan only operation depending on what temperature you have selected in relation to the actual room temperature.
- The air conditioner will control room temperature automatically around the temperature point set by you.
- Under AUTO mode, you can not change the fan speed.

FAN operation

- Press the "MODE" button until the "FAN " indicator light comes on.
- Press the "FAN SPEED" button to select the desired fan speed. The temperature cannot be adjusted.
- Do not connect the duct to window.

TIMER operation

- When the unit is on, press the Timer button, the TIMER OFF indicator light illuminates. It indicates that the Auto Stop program is initiated.
- When the unit is off, press the Timer button, the TIMER ON indicator light illuminates. It indicates that the Auto Start program is initiated.
- Press or hold the UP or DOWN buttons to change the time by 0.5 hour increments, up to 10 hours, then at 1 hour increments up to 24 hours. The control will count down the time remaining until start.
- The selected time will register in 5 second and the system will automatically revert back to display the previous temperature setting.
- Turning the unit ON or OFF at any time or adjusting the timer setting to 0.0 will cancel the Auto Start/ Stop timed program.
- When an error or malfunction (E1 or E2) occurs, the Auto Start/Stop timed program will also be cancelled.

SLEEP operation

By pressing the sleep button, the selected temperature will increase(cooling) or decrease (heating) by 2°F/1°C over 30 minutes. The temperature will then increase(cooling) by another 2°F/1°C after an additional 30 minutes. This new temperature will be maintained for 7 hours before it returns to the originally selected temperature. This ends the Sleep mode and the unit will continue to operate as originally programmed.

NOTE: This feature is unavailable under FAN or DRY mode.

OPERATING INSTRUCTIONS

Other features

Auto-Restart

If there is a loss of power, once power is restored, the unit will automatically reset in the last mode it was operating prior to the power failure.

Compressor Time Delay

After the unit has stopped, it can not be restarted for 3 minutes. This is to protect the unit's compressor. Operation will automatically start after 3 minutes.

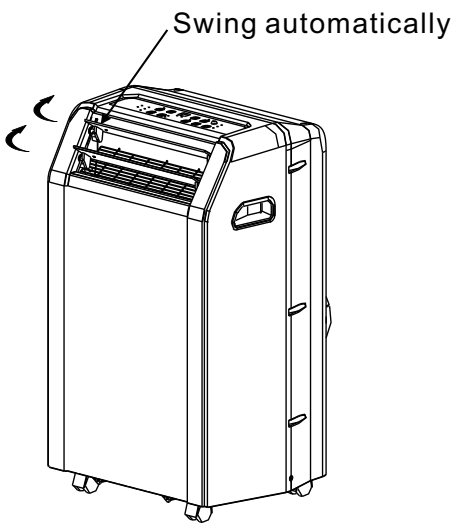

Air flow direction adjustment

The louver can be adjusted automatically. Fig. 4.

- When power is ON, the louver opens fully. Use the SWING button on the remote controller to stop the louver at a desired angle.
- If the louver is placed in a position which would affect the cooling process of the air conditioner, it will automatically change the swing direction.
- If you press the SWING button for more than 2 seconds, the auto swing feature will stop. The louver swings as shown in Fig. 4.

Fig.4

INSTALLATION INSTRUCTIONS

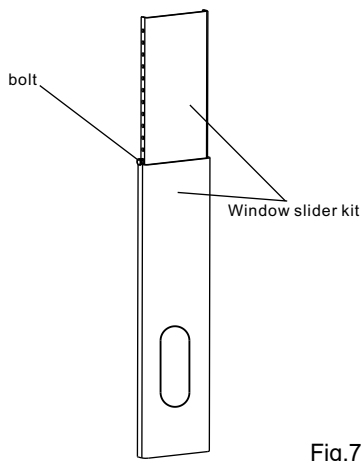
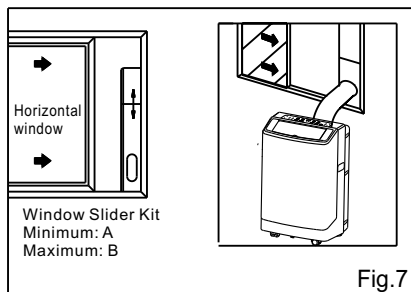
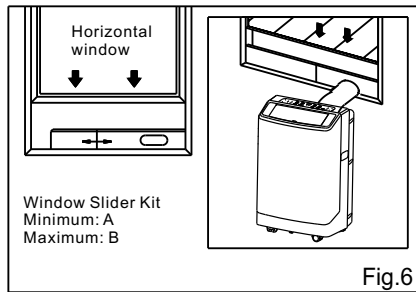
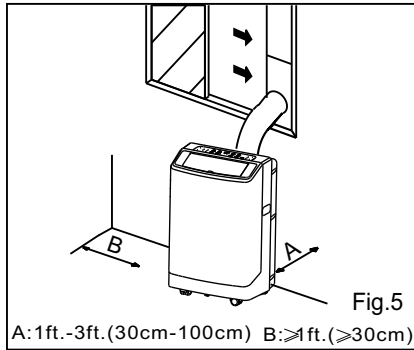

INSTALLATION INSTRUCTIONS

Location

- The air conditioner should be placed on a firm foundation to minimize noise and vibration. For safe and secure positioning, place the unit on a smooth, level floor strong enough to support the unit.
- The unit has casters to aid placement, but it should only be rolled on smooth, flat surfaces. Use caution when rolling on carpet surfaces. Do not attempt to roll the unit over objects.
- The unit must be placed within reach of a properly rated grounded socket.
- Never place any obstacles around the air inlet or outlet of the unit.
- Allow 1ft.-3ft. (30cm to 100cm) of space from the wall with for efficient air-conditioning. (Fig.5)

Window slider kit Installation

Your window slider kit has been designed to fit most standard "Vertical" and "horizontal" window applications. However, it may be necessary for you to improvise/modify some aspects of the installation procedures for certain types of windows. Please refer to Fig. 6 & Fig.7 for minimum and maximum window openings. Window slider kit can be fixed with a bolt (see Fig.7a).

Note: If the window opening is less than the mentioned minimum length of the window slider kit, cut the one with a hole in it to fit the window opening. Do never cut out the hole in window slider kit.

A		B	
Minimum		Maximum	
in.	cm	in.	cm
26-9/16	67.5	48-1/2	123

INSTALLATION INSTRUCTIONS

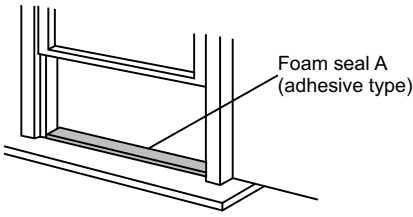

Fig.8

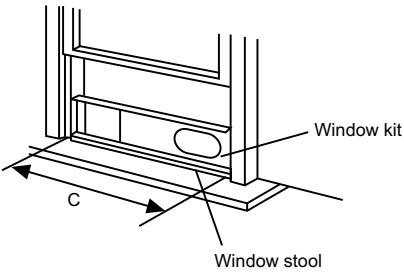

Fig.9

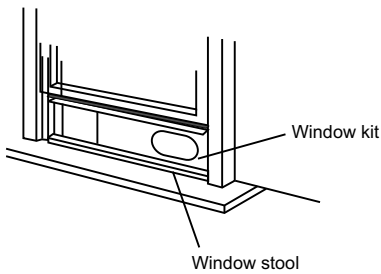

Fig.10

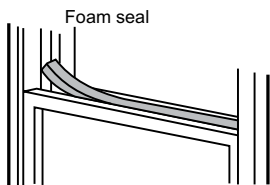

Fig.11

Installation in a double-hung sash window

1. Cut the foam seal (adhesive type) to the proper length and attach it to the window stool. Fig.8
2. Attach the window slider kit to the window stool. Adjust the length of the window slider kit according to the width of window, shorten the adjustable window kit if the width of window is less than 26.5" (67.5 cm). Open the window sash and place the window slider kit on the window stool. Fig.9
3. Cut the foam seal (adhesive type) to the proper length and attach it on the top of the window. Shown as in Fig.10
4. Close the window sash securely against the window.
5. Cut the foam seal to an appropriate length and seal the open gap between the top window sash and outer window sash. Shown as in Fig.11.

	C
Min-max.	26.5"~ 48.5" (67.5-123 cm)

INSTALLATION INSTRUCTIONS

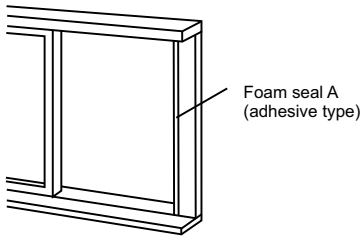

Fig.12

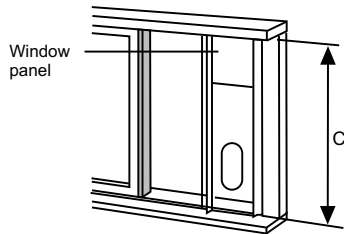

Fig.13

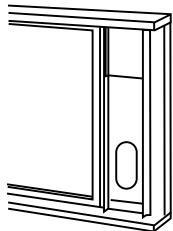

Fig.14

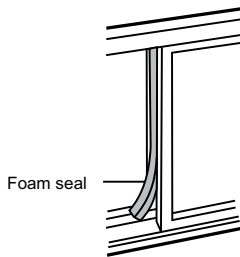

Fig.15

Installation in a sliding sash window

1. Cut the foam seal (adhesive type) to the proper length and attach it to the window frame. See Fig.12.
2. Attach the window slider kit to the window stool. Adjust the length of the window slider kit according to the width of window, shorten the adjustable window kit if the width of window is less than 26.5" (67.5 cm). Open the window sash and place the window slider kit on the window stool. See Fig.13.
3. Cut the foam seal (adhesive type) to the proper length and attach it on the top of the window. Shown as in Fig.14.
4. Close the sliding sash securely against the window.
5. Cut the foam seal to an appropriate length and seal the open gap between the top window sash and outer window sash. Shown as in Fig.15.

	C
Min-max.	26.5"~ 48.5" (67.5-123 cm)

INSTALLATION INSTRUCTIONS

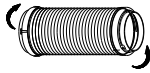

Fig.16

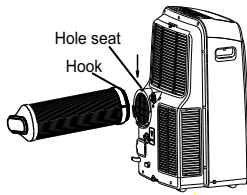

Fig.17

Exhaust hose installation:

The exhaust hose and adaptor must be installed or removed in accordance with the usage mode.

COOL or AUTO mode	Install
FAN, OR DEHUMIDIFY mode	Remove

1. Install the adaptor onto the exhaust hose as shown in Fig.16. Refer to the previous pages for window kit installation.
2. Insert the hook of the Exhaust hose into the hole seat of the air outlet and slide down the Exhaust hose along the arrow direction (See Fig.17) for installation.

IMPORTANT:

DO NOT OVER EXTEND OR BEND THE EXHAUST HOSE

⚠ CAUTION:

Make sure that there are no obstacles around the air outlet of the exhaust hose provide at least 1.5ft.(500mm) clearance in order for the exhaust system to work properly.

INSTALLATION INSTRUCTIONS

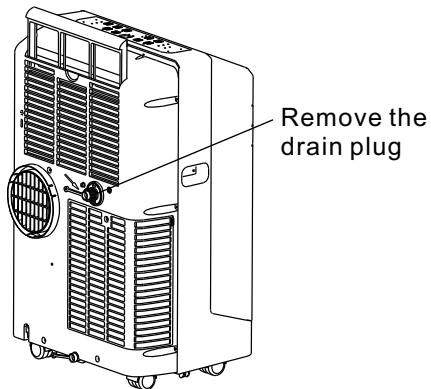

Fig.18

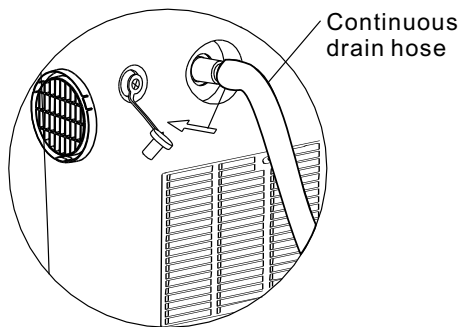

Fig.19

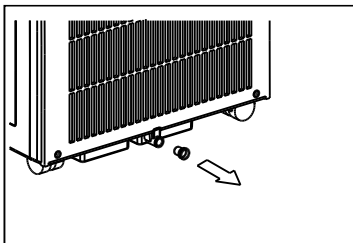

Fig.20

Condensate drainage:

- While operating in Dry (dehumidifying) mode, remove the drain plug from the back of the unit, install the drain connector (5/8" universal female mender) with .3/4" hose (locally purchased). For the models without drain connector, just attach the drain hose to the hole. Place the open end of the hose directly over the drain area in your basement floor. Please refer to Fig.18 & 19.
- When the water level of the bottom tray reaches a predetermined level, the unit beeps 8 times, the digital display area shows "P1". At this time the air conditioning/dehumidification process will immediately stop. However, the fan motor will continue to operate (this is normal). Carefully move the unit near a drain location, remove the bottom drain plug and let the water drain away (Fig.20). Restart the machine until the "P1" symbol disappears. If the error repeats, call for service.

NOTE: Be sure to reinstall the bottom drain plug before using the unit.

CARE AND MAINTENANCE

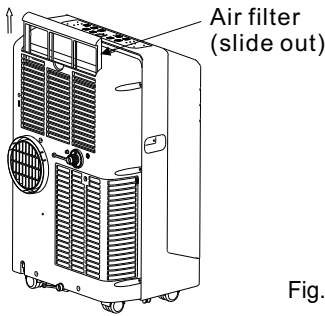

Fig.21

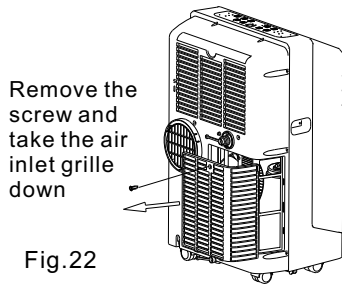

Fig.22

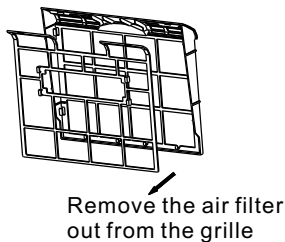

Fig.23

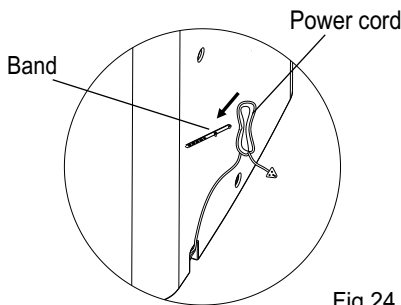

Fig.24

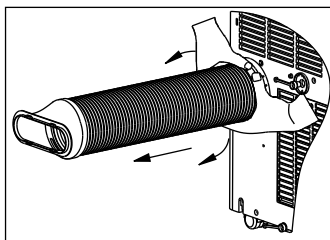

Fig.25

CARE AND MAINTENANCE

IMPORTANT:

- 1) Be sure to unplug the unit before cleaning or servicing.
- 2) Do not use gasoline, paint thinner or other chemicals to clean the unit.
- 3) Do not wash the unit directly under a tap or using a hose. It may cause electrical danger.
- 4) If the power cord is damaged, it should be repaired by an authorized servicer.

1. Air filter

- Clean the air filter at least once every two weeks.
- Removal
This unit has two filters. Grasp the upper filter tab(Fig.21), pull the filter out then up. Remove the lower filter by loosening the screw, taking down the air inlet grille, then removing the air filter as shown in Fig.22 & 23.
- Cleaning
Wash the air filter by immersing it gently in warm water (about 104°F/40°C) with a neutral detergent. Rinse the filter and dry it in a shady place.
- Installation
Insert the upper air filter from upward after cleaning, attach the lower air filter on the air inlet grille, then reinstall the grille by using the screw.

2. Unit cabinet

- Use a lint-free damp cloth with neutral detergent to clean the unit enclosure. Finished by drying with a dry clean cloth.

3. Unit storage when not in use

- Remove the rubber plug at the back of the unit and attach a hose to the drain outlet. Place the open end of the hose directly over the drain area in your basement floor (See Fig.19 & 20).
- Remove the plug from the bottom drain outlet, all the water in the bottom tray will drain out (See Fig.23).
- Keep the appliance running in FAN mode for half a day in a warm room to dry the appliance inside and prevent mold from forming.
- Stop the appliance and unplug it, wrapped the cord and bundle it with the buckle (Fig.24). Remove the batteries from the remote controller.
- Clean the air filter and reinstall it.
- Unscrew the exhaust hose and pull out for uninstallation(Fig.25).

TROUBLESHOOTING TIPS

TROUBLESHOOTING

PROBLEM	POSSIBLE CAUSES	SUGGESTED REMEDIES
1. Unit does not Start when Pressing on/off Button	- P1 appears in the display window	Drain the water in the bottom tray.
	- Room temperature is lower than the set temperature.(Cooling mode)	Reset the temperature.
2. Not cool enough	- The windows or doors in the room are not closed.	Make sure all the windows and doors are closed.
	- There are heat sources inside the room.	Remove the heat sources if possible.
	- Exhaust air duct is not connected or blocked.	Connect the duct and make sure it can function properly.
	- Temperature setting is too high.	Decrease the set temperature.
	- Air filter is blocked by dust.	Clean the air filter.
4. Noisy or vibration	- The ground is not level or not flat enough.	Place the unit on a flat, level ground if possible.
5. Gurgling sound	- The sound comes from the flowing of the refrigerant inside the air-conditioner.	It is normal.
6. Power shut off at Heating mode	- The automatic over heat protection function. When the temperature at the air outlet exceed 70°C/158°F,the device will stop.	Switch on again after the unit has cool down.

Design, material, performance data and components
subject to change without notice.

HEAT CONTROLLER, INC.

1900 Wellworth Ave., Jackson, MI 49203 ♦ Ph. 517-787-2100 ♦ Fax 517-787-9341

THE QUALITY LEADER IN CONDITIONING AIR

www.heatcontroller.com