



060 00012 55124 2

U284-0170X01

Printed in Japan 2006.05

# Rinnai®

## Wireless Controller Manual For Rinnai Water Heater MC-502RC-1US-S

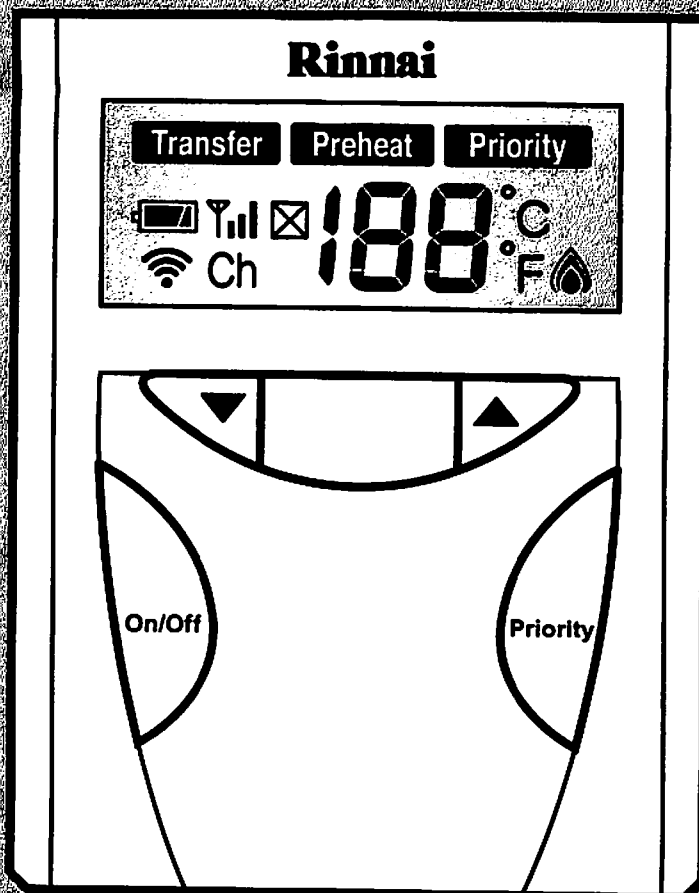

# User's Guide

To the User: For your safety, read this User's Guide thoroughly before use. See the water heater Installation Manual for information on registration.

To the Installer: Thoroughly explain to the customer how to use the device and give this User's Guide to the customer for future reference.



## Table of Contents

(1) Safety Precautions .....	1
(2) Installation Location .....	2
(3) Parts List .....	3
(4) Wireless Controller Operation .....	3
(5) Trouble Shooting .....	6
(6) Battery Replacement .....	9

(This device complies with Part 15 of FCC Rules and RSS-Gen of IC Rules.)  
Operation is subject to the following two conditions: (1) this device may not cause interference, and (2) this device must accept any interference, including interference that may cause undesired operation of this device.

## (1) Safety Precautions

For your safety the following safety alert symbols may be used in this guide to indicate the level of danger and degree of injury that may result if these direction are not followed.

	Indicates an imminently hazardous situation which, if not avoided, will result in death or serious injury.
	Indicates a potentially hazardous situation which, if not avoided, could result in death or serious injury.
	Indicates a potentially hazardous situation which, if not avoided, could result in minor or moderate injury. It may also be used to alert against unsafe practices.

## (1) Safety Precautions

The following precautions must be followed.

- Radio Waves
  - Do not use this wireless controller near electrically powered medical equipment. It will affect the medical equipment and cause a malfunction.
  - Do not use this wireless controller near automatically controlled devices such as automatic doors and fire alarm systems. It may cause a malfunction.
- FCC Warning
  - Changes or modifications not expressly approved by the party responsible for compliance could void the user's authority to operate the equipment.

## (2) Installation Location

- In order for the wireless controller to communicate with the transceiver do not install either unit in an enclosure surrounded by metal.
- Keep out of reach of children.
- Do not install the wireless controller where it is subject to direct sunlight.
- The wireless controller in the holder is water proof.
- The wireless controller is designed to be used in the holder.

### CAUTION

- Install in location that is easily accessible.
- Allow for sufficient space for inspection and possible repair of the wireless controller.

### (3) Parts List

Confirm that the following parts are contained in the package.

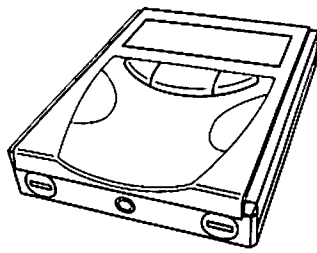
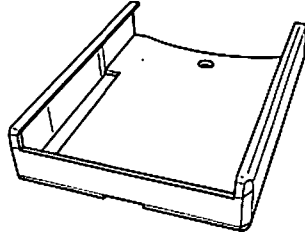
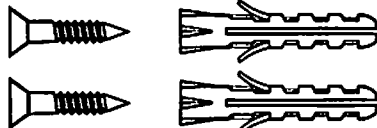
Part	Appearance
(1) Wireless controller	
(2) Holder	
(3) Wood screws (2) Anchors (2)	

### (4) Wireless Controller Operation

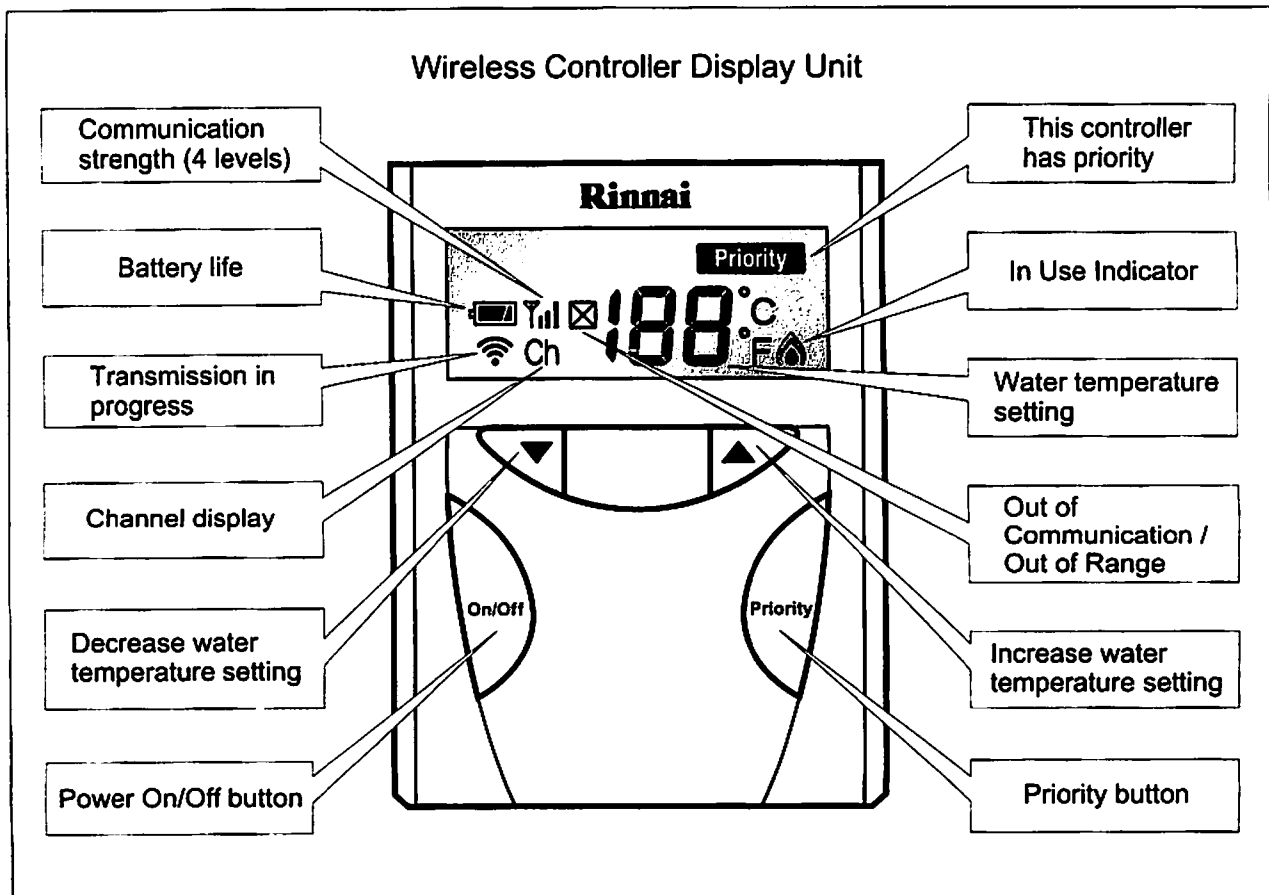

## (4) Wireless Controller Operation

### Wireless Controller Care and Use

- Use
  - Do not drop or step on the wireless controller.
  - Do not install in a location far away from the water heater.
- To change temperature display from °F to °C or vice versa,
  - Turn off the wireless controller.
  - Press the ON/OFF button for 5 seconds.
- Temperature Display Response Time
  - When using the wireless controller to change the temperature setting, there may be a delay of up to 15 seconds before other controllers display the new temperature. This is not a malfunction but a feature that saves battery life and allows the transceiver and the wireless controller with priority to be in constant communication.

- Battery Life

The display will show one of three levels of battery life:

- Symbol displays full battery. Batteries are adequately charged. 

- Symbol displays one fourth of battery. Batteries are weak. 

- Symbol flashes. Batteries need replacing.

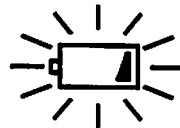

## (4) Wireless Controller Operation

### CONTROLLERS SET PATTERN/TEMPERATURE TABLES

Temperature controllers allows precise temperature control by the user. When used correctly, the hot water unit will deliver the selected temperature, even when the water flow is varied, or more than one tap is in use. Each Temperature Controller can be individually programmed, however the water heater unit can only deliver one set temperature at any time. The available temperatures (°F) are as follows:

#### Temperature Table by Models

Model	Temperature															
REU-V1616W REU-V2020W REU-V2526W REU-V2532W REU-V2532WD REU-V2532FFU REU-V2532FFUD REU-V2520FFU REU-V3237W REU-V3237FFU (°F)	98	100	102	104	106	108	110	115	120	125	130	135	140	—	—	—
REU-V1616WC REU-V2020WC REU-V2520FFUC (°F)	—	—	—	—	—	—	—	—	120	125	130	135	140	150	160	185
REU-V2532WG REU-V2532WGD REU-V2532FFUC REU-V2532FFUCD REU-V3237WC REU-V3237FFUC (°F)	98	100	102	104	106	108	110	115	120	125	130	135	140	150	160	185
Approx. Temperature (°C)	37	38	39	40	41	42	43	46	49	52	54	57	60	66	71	85

#### Suggested temperatures are:

Kitchen 120°F, Shower 98°F - 110°F, Bath fill 102°F - 114°F

These temperatures are suggestions only. You may find higher or lower temperatures more comfortable. Maintaining lower temperatures helps save energy. To obtain water temperatures lower than 98°F, simply add cold water.

Deluxe Controllers are an optional extra. 'Controller' and 'Deluxe' Controllers can be installed together. Controllers allow temperature selection only. 'Deluxe' Controllers have temperature selection, bath fill and clock functions.

Controllers allow the water temperature to be set from the various locations where they are installed. The temperature selected will be available to all outlets.

## (4) Wireless Controller Operation

Each row represents possible combinations of controllers that are compatible with one another.

1	MC-91-1US	MC-502RC-S	————	————
2	MC-91-1US	MC-502RC-S	MC-502RC-S	————
3	MC-91-1US	MC-502RC-S	MC-502RC-S	MC-502RC-S
4	MC-502RC-S	MC-502RC-S	MC-502RC-S	MC-502RC-S
5	MC-100V	BC-100V	BC-100V	MC-502RC-S
6	MC-100V	BC-100V	MC-502RC-S	MC-502RC-S
7	MC-502RC-S	————	————	————

## (5) Trouble Shooting

### • Problems

- Wireless controller does not operate (does not heat) → Are the gas, water and water supply device fully open?
- Water is not being heated → Is the temperature setting correct? Is the battery life display normal?
- The display is off → To extend battery life, the display turns off temporarily if the water supply is not used for 10 minutes.

Does the display turn on when the faucet is opened and the water supply is used? Press the power switch when the water supply is started.

## (5) Trouble Shooting

The Rinnai Water Heater has the ability to check its own operation continuously. If a fault occurs, an Error Message will flash on the Digital Display of the Wireless Controller. This assists with diagnosing the fault, and may enable you to overcome a problem without a service call. Please identify the code displayed when inquiring about service.



### WARNING

Failure to remedy faults may result in severe burns, scalds, and/or death.

Error	Faulty	Remedy
02	No burner operation during freeze protection mode	Service Call
03	Power interruption during Bath fill (Water will not flow when power returns).	Turn off all hot water taps. Press ON/OFF twice.
10	Air Supply or Exhaust Blockage	<p>Ensure Rinnai approved venting materials are being used.</p> <p>Check that nothing is blocking the flue inlet or exhaust.</p> <p>Check all vent components for proper connections.</p> <p>Ensure vent length is within limits.</p> <p>Ensure condensation collar was installed correctly.</p> <p>Verify dip switches are set properly.</p> <p>Check fan for blockage.</p>
11	No Ignition	<p>Check that the gas is turned on at the water heater, gas meter, or cylinder.</p> <p>Ensure gas type and pressure is correct.</p> <p>Ensure gas line, meter, and/or regulator is sized properly.</p> <p>Bleed all air from gas lines.</p> <p>Verify dip switches are set properly.</p> <p>Ensure appliance is properly grounded.</p> <p>Disconnect all MSA controls.</p> <p>Ensure igniter is operational.</p> <p>Check igniter wiring harness for damage.</p> <p>Check gas solenoid valves for open or short circuits.</p> <p>Remove burner cover and ensure all burners are properly seated.</p> <p>Remove burner plate and inspect burner surface for condensation or debris.</p>
12	Flame Failure	<p>Check that the gas is turned on at the water heater and gas meter. Check for obstructions in the flue outlet.</p> <p>Ensure gas line, meter, and/or regulator is sized properly.</p> <p>Ensure gas type and pressure is correct.</p> <p>Bleed all air from gas lines.</p> <p>Ensure proper Rinnai venting material was installed.</p> <p>Ensure condensation collar was installed properly.</p> <p>Ensure vent length is within limits.</p> <p>Verify dip switches are set properly.</p> <p>Ensure appliance is properly grounded.</p> <p>Disconnect keypad.</p> <p>Disconnect all MSA controls if installed.</p> <p>Check power supply for loose connections.</p> <p>Check power supply for proper voltage and voltage drops.</p> <p>Ensure flame rod wire is connected.</p> <p>Check flame rod for carbon build-up.</p> <p>Disconnect and re-connect all wiring harnesses on unit and PC board.</p> <p>Check all components for electrical short.</p> <p>Check gas solenoid valves for open or short circuits.</p> <p>Remove burner plate and inspect burner surface for condensation or debris.</p>



## (5) Trouble Shooting

Error	Faulty	Remedy
14	Thermal Fuse	<p>Check gas type of unit and ensure it matches gas type being used.            Check for restrictions in air flow around unit and vent terminal.            Check for low water flow in a circulating system causing short-cycling.            Ensure dip switches are set to the proper position.            Check for foreign materials in combustion chamber and/or exhaust piping.            Check heat exchanger for cracks and/or separations.            Check heat exchanger surface for hot spots which indicate blockage due to scale build up. Refer to instructions in manual for flushing heat exchanger.            Measure resistance of safety circuit.            Ensure high fire and low fire manifold pressure is correct.            Check for improper conversion of product.</p>
16	Over Temperature Warning	<p>Check for restrictions in air flow around unit and vent terminal.            Check for low water flow in a circulating system causing short-cycling.            Check for foreign materials in combustion chamber and/or exhaust piping.            Check for clogged heat exchanger.</p>
32	Outgoing Water Temperature Sensor Fault	<p>Check sensor wiring for damage.            Measure resistance of sensor.            Clean sensor of scale build up.            Replace sensor.</p>
33	Heat Exchanger Outgoing Temperature Sensor Fault	<p>Check sensor wiring for damage.            Measure resistance of sensor.            Clean sensor of scale build up.            Replace sensor.</p>
34	Combustion Air Temperature Sensor Fault	<p>Check for restrictions in air flow around unit and vent terminal.            Check sensor wiring for damage.            Measure resistance of sensor.            Clean sensor of scale build up.            Ensure fan blade is tight on motor shaft and is in good condition.            Replace sensor.</p>
52	Modulating Solenoid Valve Signal Abnormal	<p>Check modulating gas solenoid valve wiring harness for loose or damage terminals.            Measure resistance of valve coil.</p>
61	Combustion Fan Failure	<p>Ensure fan will turn freely.            Check wiring harness to motor for damaged and/or loose connections.            Measure resistance of motor winding.</p>
65	Water Flow Servo Faulty (Does not stop flow properly)	<p>Water Flow Servo or wiring faulty. Check Water Flow Servo wiring harness connection.            Measure resistance of Water Flow Servo wiring.            If blank screen is present on remote control then the Water Flow Servo has shorted out. Unplug Water Flow Servo. If remote lights up and unit starts operating then replace Water Flow Servo.</p>
71	SV0, SV1, SV2, and SV3 Solenoid Valve Circuit Fault	<p>Check wiring harness to all solenoids for damage and/or loose connections.            Measure resistance of each solenoid valve coil.</p>
72	Flame Sensing Device Fault	<p>Ensure flame rod is touching flame when unit fires.            Check all wiring to flame rod for damage.            Remove flame rod and check for carbon build-up; clean with sand paper.            Check inside burner chamber for any foreign material blocking flame at flame rod.            Measure micro amp output of sensor circuit with flame present.            Replace flame rod.</p>
LC (00)	Scale Build-up in Heat Exchanger (when checking maintenance code history "00" is substituted for "LC" )	<p>Flush heat exchanger. Refer to instructions in manual.            Replace heat exchanger.</p>
No code	Nothing happens when water flow is activated.	<p>Clean inlet water supply filter.            On new installations ensure hot and cold water lines are not reversed.            Check for bleed over. Isolate unit from building by turning off hot water line to building. Isolate the circulating system if present. Open your pressure relief valve; if unit fires, there is bleed over in your plumbing.            Ensure you have at least the minimum flow rate required to fire unit.            Ensure turbine spins freely.            Measure the resistance of the water flow control sensor.            Remote control does not light up but you have 12 VDC at the terminals for controls.</p>

## (6) Battery Replacement

- Low batteries will inhibit communication with the transceiver.
- The water heater will maintain a safe temperature if there is a demand for hot water while the batteries are being replaced.
- The battery replacement interval is about 1 year.
- Replace batteries with four new batteries.  
Do not use manganese batteries.
- Remove the batteries if the wireless controller is to be left inactive for a long time.

### Battery Handling

- Remove batteries before discarding the device.
- Do not mix new and old batteries.
- In the unlikely case of leakage, rinse affected area well with water.

**⚠ WARNING** Seek medical help immediately if any leakage enters the eyes.

### **⚠ CAUTION**

- It is not safe to use batteries that have been exposed to excessive heat or flame.
- Do not insert batteries if the wireless controller has shorted out or is disassembled.

If the display becomes dim, replace the batteries according to the following procedures:

1. Turn the power switch OFF.
2. Remove the wireless controller from the holder.

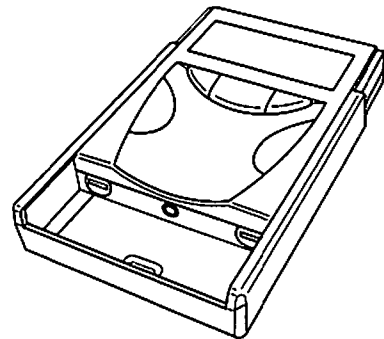

3. Remove the battery cover on the bottom of the wireless controller.  
With a coin or a flat head screw driver turn in the direction of lock release to remove the cover (2 locations).

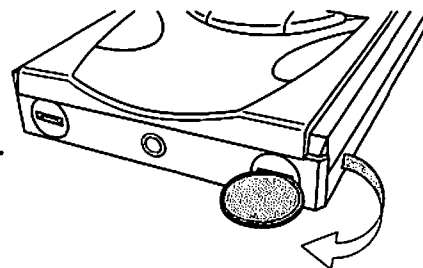

## (6) Battery Replacement

### 4. Replace the batteries.

Replace the four batteries with new ones.  
Insert the batteries with the correct polarity.

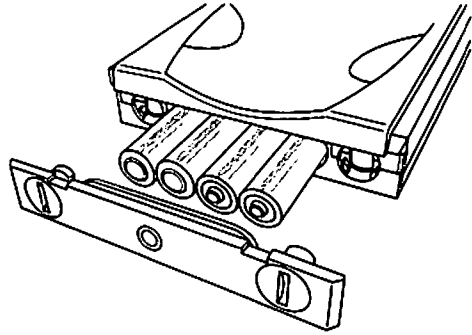

### 5. Insert the battery cover, and tighten the locks on the cover. Ensure that the wireless controller display lights up and that the battery life indicator is fully lit.

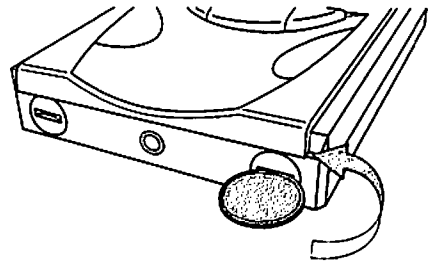

### 6. Insert the wireless controller so that it rests against the bottom of the holder.

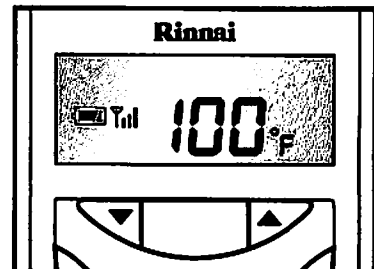
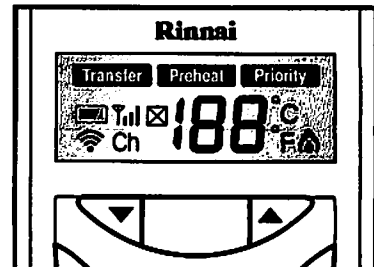

**NOTE** Except for changing the batteries, the unit should remain in the holder.

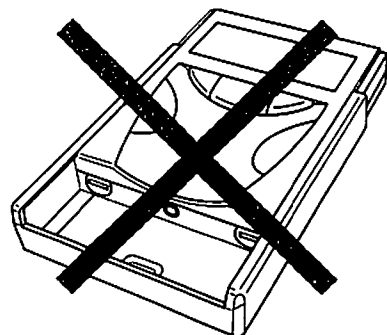

# Ask about

Rinnai's other fine products.

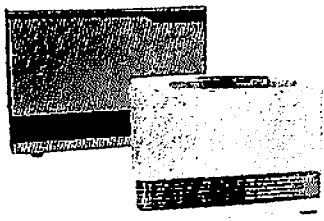

## Direct Vent Heaters

- "Cool-to-the-Touch" cabinet
- Easily Installed and Safe for Any Room
- Up to 84% Efficient
- Electronic Ignition - No Pilot Light
- Propane or Natural Gas
- Earthquake Proof-Tilt Switch
- Whisper Quiet Blower
- Primary Heat Source

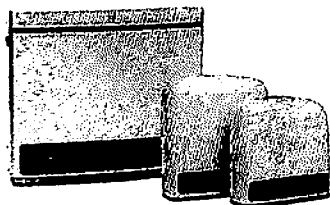

## Vent-Free Zone Heaters

- Programmable Thermostat
- 99.9% Efficient, Vent-free
- No Visible Flame
- Oxygen Depletion Sensor
- Secondary Heat Source

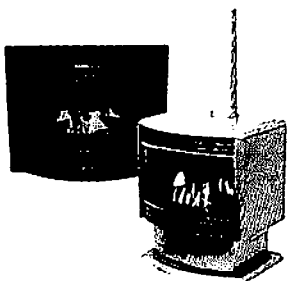

## Free-Standing and In-Built Fireplaces

- Standard Dimensions
- Thermostat Control
- State-of-the-Art Three Gas Burner System
- Electronic Push Button Ignition
- Remote/Keypad Control
- Programmable Timers



## Infrared Heaters

- Wall-mountable or Free-standing
- Works in Power Outages
- 99.9% Energy Efficient
- Natural or Propane Gas
- ODS Safety Sensor
- Ideal for Emergency Heating

# Rinnai

HEATERS | WATER HEATERS | FIREPLACES

Rinnai America Corporation  
103 International Drive  
Peachtree City, GA 30269