

Ubbink Vent Components - Concentric Non-Condensing

- For concentric venting, non-condensing models.
- Concentric venting incorporates a condensate collector and does not require an "adapter" vent component.
- Plastic vent components consist of an outer plastic vent for the air intake and an inner metal vent for the exhaust gases. Metal vent components consist of metal inner and outer vents.
- Plastic and metal vent components are completely interchangeable.

Refer to the Rinnai installation manual and the Ubbink installation instructions for complete installation details and requirements.

PLASTIC VENT COMPONENTS

21" Non-Condensing Horizontal Termination Diverter Kit
Part No.: 223187

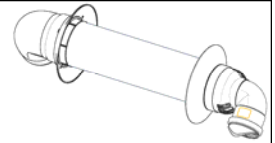

All Weather Termination Kits

(Part No.: STDKITVA-A21)

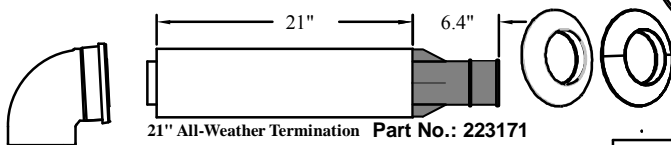

21" All-Weather Termination Part No.: 223171

All Components Also Sold Separately

(Part No.: STDKITVA-A)

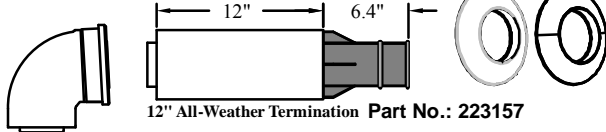

12" All-Weather Termination Part No.: 223157

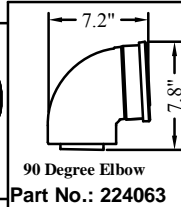

90 Degree Elbow Part No.: 224063

Universal Non-Condensing

(Part No.: 223181)

11.5" Universal Non-Condensing Termination Kit

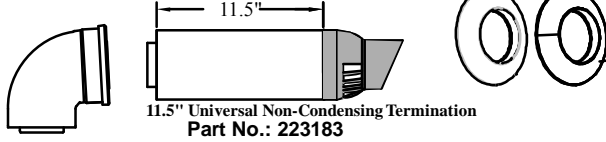

11.5" Universal Non-Condensing Termination Part No.: 223183

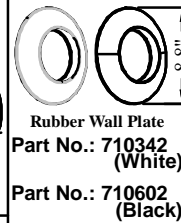

Rubber Wall Plate Part No.: 710342 (White) Part No.: 710602 (Black)

(Part No.: 223182)

21" Universal Non-Condensing Termination Kit

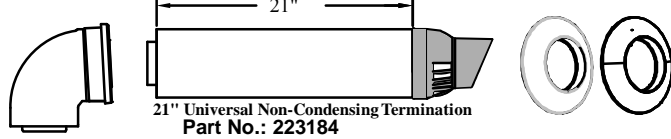

21" Universal Non-Condensing Termination Part No.: 223184

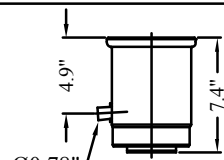

Condensate Collector Part No.: 224069

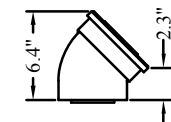

45 Degree Elbow Part No.: 224050

Eff. Length (2.2 - 12.0 in)

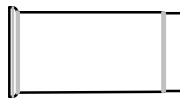

Telescoping Vent Length Part No.: 224054

Roof Discharge Termination 18" Part No.: 184118-S

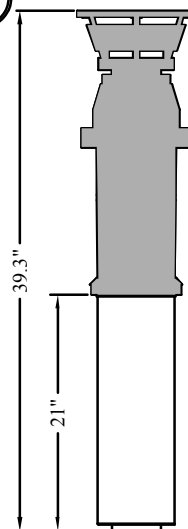

Roof Discharge Termination 38" (Cold Climate) Part No.: 184119

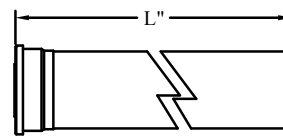
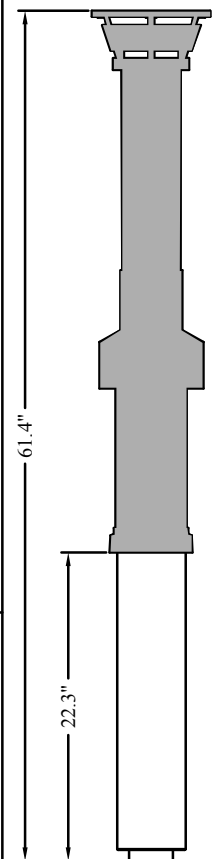

Vent Pipe Extension

| Length "L" | Part Number |
|------------|-------------|
| 10" | 224051 |
| 19.5" | 224052 |
| 39" | 224053 |

Ubbink Vent Components - Concentric Non-Condensing

METAL VENT COMPONENTS

All-Weather Termination Kit

(Metal) (Part No.: 223168)

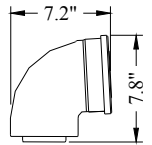

90 Degree Elbow (Metal)
Part No.: 224255

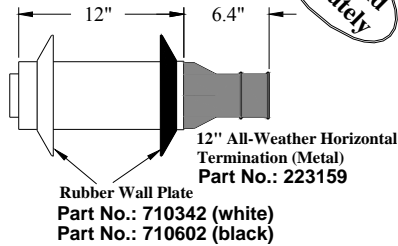

12" All-Weather Horizontal Termination (Metal)
Part No.: 223159
Rubber Wall Plate
Part No.: 710342 (white)
Part No.: 710602 (black)

Also Sold Separately

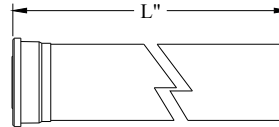

Vent Pipe Extension

| Length "L" | Part Number |
|------------|-------------|
| 10" | 224260 |
| 19.5" | 224265 |
| 39" | 224270 |

Roof Discharge Termination 18" (Metal)

Part No.: 184127

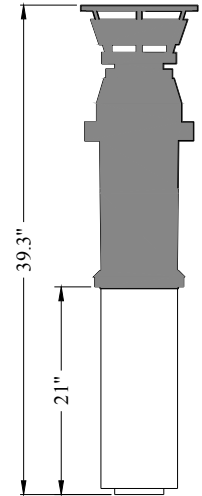

Standard Termination Kit

(Metal) (Part No.: 223167)

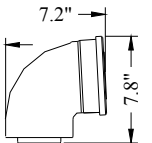

90 Degree Elbow (Metal)
Part No.: 224255

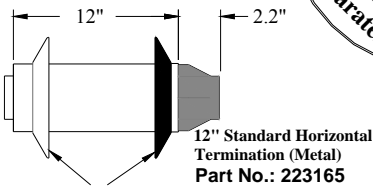

12" Standard Horizontal Termination (Metal)
Part No.: 223165
Rubber Wall Plate
Part No.: 710342 (white)
Part No.: 710602 (black)

Also Sold Separately

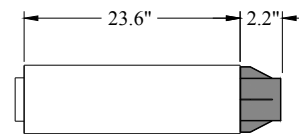

23.6" Standard Horizontal Termination (Metal)
Part No.: 223155

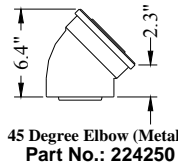

45 Degree Elbow (Metal)
Part No.: 224250

Eff. Length (2.0 - 11.5 in)

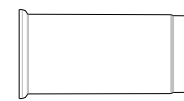

Telescoping Vent Length (Metal)
Part No.: 224275

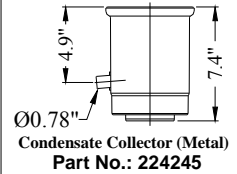

Condensate Collector (Metal)
Part No.: 224245

ACCESSORIES

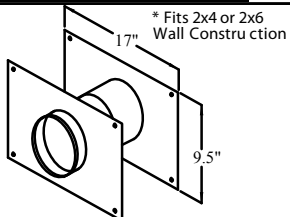

Thimble
Part No.: 224045

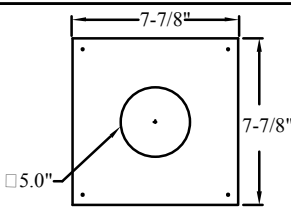

Metal Pass Through Plate
Part No.: 224097



| Roof Pitch | Part Number |
|---------------|-------------|
| 1/12 to 6/12 | 189950 |
| 6/12 to 12/12 | 189951 |
| 8/12 to 16/12 | 189952 |

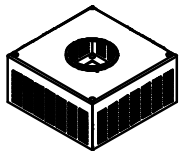

Universal Bug Guard
Part No.: 224042

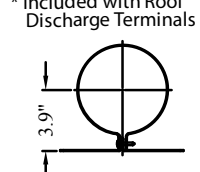

Pipe Clamp
Part No.: 169044

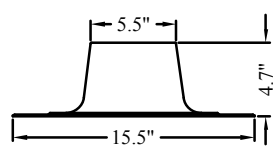

Roof Flashing - Flat
Part No.: 146141

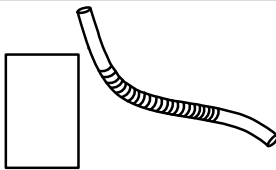

Condensate Trap
Part No.: 222053

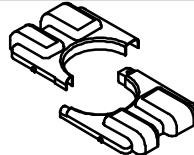

NSF Cover
Part No.: 224040

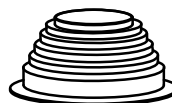

Flashing for Metal Roof
Part No.: 242141

Raised Horizontal Termination Kit "Snorkel"
Part No.: 224046

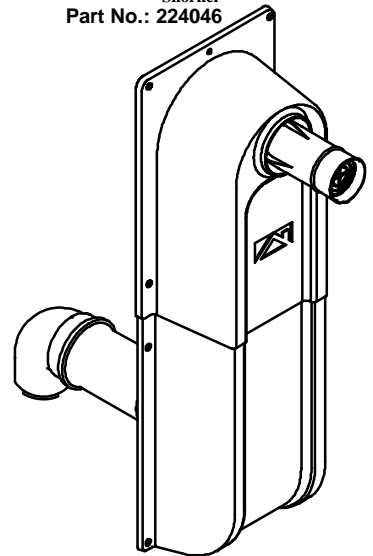

Kit Includes:
14.2" Vent extension, Qty 3 - 90° Elbow, (0224063), Telescoping vent extension (224054) 19.5" Vent pipe extension (224052), Special wall terminal, Cover