

INSTALLATION & OPERATING INSTRUCTIONS for SPLIT SYSTEM HEAT PUMPS



All information contained herein is subject to change without notice.

Made in the USA by:

Goodman Manufacturing Company, L.P.

2550 North Loop West, Suite 400, Houston, TX 77092

www.goodmanmfg.com or www.amana-hac.com

© 2004-2005 Goodman Manufacturing Company, L.P.

INDEX

Introduction

Checking Product Received	2
Message to the Homeowner	2
Before Beginning Installation	2
Installing the Split System Heat Pump	2

Replacement Parts

Ordering Parts	2
Service Parts Department	2

Safety Instructions

Recognize Safety Symbols, Words and Labels	3
--	---

Codes and Regulations

General	3
EPA Regulations	3
National Codes	3

Scroll Compressors

Pump Down Procedures	3
Crankcase Heaters	3
Unbrazing System Components	3

Installation

General	3
Pre-Installation Checkpoints	3
Clearance	3
Location	4
Elevation Limitations	4

Electrical

General	4
---------------	---

Components

Contactors	5
Crankcase Heater	5
Condenser Motor	5
Compressor	5
Defrost Control	5
Loss of Charge Protector	5
Outdoor Thermostats	5
Reversing Valve Coil	5

Piping

General	5
Line Set Installation Instructions	5

Evaporator Coil

General	6
---------------	---

Indoor CFM and Heating Capacity Determination

Airflow Determination	6
Airflow Test Instruments	6
Temperature Rise Resistive Heat Method	6
Temperature Rise Heat Pump Only Method	6

Refrigerant Charge Determination and Adjustments - Cooling

Weigh In Charge Method	7
Superheat Method	7
Expansion Valve System Method	8

Heat Pump - Heating Cycle

Hot Gas Method	8
----------------------	---

Start-Up Procedure and Checklist

General	8
---------------	---

Operation - Defrost Control

Timing	9
Field Testing/Troubleshooting	9
General Explanation and Guidance	9

Maintenance

General	10
Common Causes of Unsatisfactory Operation	11

Wiring Diagram

B1724425	12
----------------	----

Thermostat Wiring

CP/ARUF/ARPF/ARPT	13
-------------------------	----

INTRODUCTION

Checking Product Received

Upon receiving the unit, inspect it for damage from shipment. Claims for damage, either shipping or concealed, should be filed immediately with the shipping company. Check the unit model number, specifications, electrical characteristics and accessories to determine if they are correct. In the event an incorrect unit is shipped, it must be returned to the supplier and must NOT be installed. The manufacturer assumes no responsibility for installation of incorrectly shipped units.

Message to the Homeowner

These instructions are addressed primarily to the installer; however, useful maintenance information is included and should be kept, after installation, for future reference.

Before Beginning Installation

Carefully read all instructions for the installation prior to installing unit. Make sure each step or procedure is understood and any special considerations are taken into account before starting installation. Assemble all tools, hardware and supplies needed to complete the installation. Some items may need to be purchased locally. After deciding where to install unit, closely look the location over - both the inside and outside of home. Note any potential obstacles or problems that might be encountered as noted in this manual. Choose a more suitable location if necessary.

Installing the Split System Heat Pump

Proper installation of the split system unit helps ensure trouble free operation. Improper installation can result in problems ranging from noisy operation to property or equipment damages, dangerous conditions that could result in injury or personal property damage and could void the warranty. Give this booklet to the user and explain it's provisions. The user should retain these instructions for future reference.

REPLACEMENT PARTS

Ordering Parts

When reporting shortages or damages, or ordering repair parts, give the complete unit model and serial numbers as stamped on the unit's nameplate. Replacement parts for this appliance are available through your contractor or local distributor. For the location of your nearest distributor, consult the white business pages, the yellow page section of the local telephone book or contact:

SERVICE PARTS DEPARTMENT
GOODMAN MANUFACTURING COMPANY, L.P.
2550 NORTH LOOP WEST, SUITE 400
HOUSTON, TEXAS 77092
(713) 861 - 2500

IMPORTANT SAFETY INSTRUCTIONS

Recognize Safety Symbols, Words, and Labels

The following symbols and labels are used throughout this manual to indicate immediate or potential hazards. It is the owner's responsibility to read and comply with all safety information and instructions accompanying these symbols. Failure to heed safety information increases the risk of serious personal injury or death, property damage and/or product damage.



DANGER

IMMEDIATE HAZARDS WHICH **WILL** RESULT IN PROPERTY DAMAGE, PRODUCT DAMAGE, SEVERE PERSONAL INJURY OR DEATH.



WARNING

HAZARDS OR UNSAFE PRACTICES **COULD** RESULT IN PROPERTY DAMAGE, PRODUCT DAMAGE, SEVERE PERSONAL INJURY OR DEATH.



CAUTION

HAZARDS OR UNSAFE PRACTICES WHICH **MAY** RESULT IN PROPERTY DAMAGE, PRODUCT DAMAGE, PERSONAL INJURY OR DEATH.



WARNING

DO NOT CONNECT TO OR USE IN CONJUNCTION WITH THIS UNIT ANY DEVICES FOR THE PURPOSE OF SAVING ENERGY OR INCREASING OPERATING EFFICIENCIES THAT ARE NOT DESIGN CERTIFIED FOR USE WITH THIS UNIT OR HAVE NOT BEEN TESTED AND APPROVED BY GOODMAN. SERIOUS PROPERTY OR PERSONAL DAMAGE, REDUCED UNIT PERFORMANCE AND/OR HAZARDOUS CONDITIONS MAY RESULT FROM THE USE OF DEVICES THAT HAVE NOT BEEN APPROVED OR CERTIFIED BY GOODMAN.



WARNING

DO NOT STORE COMBUSTIBLE MATERIALS OR USE GASOLINE OR OTHER FLAMMABLE LIQUIDS OR VAPORS IN THE VICINITY OF THIS APPLIANCE SO AS TO PREVENT THE RISK OF PROPERTY DAMAGE OR PERSONAL INJURY. HAVE YOUR CONTRACTOR POINT OUT AND IDENTIFY THE VARIOUS CUT-OFF DEVICES, SWITCHES, ETC. THAT SERVES YOUR COMFORT EQUIPMENT.



WARNING

DO NOT, UNDER ANY CIRCUMSTANCES, CONNECT DUCT WORK TO ANY OTHER HEAT PRODUCING DEVICE SUCH AS FIREPLACE INSERT, STOVE, ETC. UNAUTHORIZED USE OF SUCH DEVICES MAY RESULT IN PROPERTY DAMAGE, FIRE, CARBON MONOXIDE POISONING, EXPLOSION, PERSONAL INJURY OR DEATH.

CODES AND REGULATIONS

General

Information contained herein pertain only for outdoor equipment installation. **NOTE:** Units are not to be installed inside the structure, units are designed for **Outdoor Use Only.**

IMPORTANT: THE UNITED STATES ENVIRONMENTAL PROTECTION AGENCY (EPA) HAS ISSUED VARIOUS REGULATIONS REGARDING THE INTRODUCTION AND DISPOSAL OF REFRIGERANTS IN THIS UNIT. FAILURE TO FOLLOW THESE REGULATIONS MAY HARM THE ENVIRONMENT AND CAN LEAD TO THE IMPOSITION OF SUBSTANTIAL FINES. BECAUSE REGULATIONS MAY VARY DUE TO PASSAGE OF NEW LAWS, WE SUGGEST A CERTIFIED TECHNICIAN PERFORM ANY WORK DONE ON THIS UNIT. SHOULD YOU HAVE ANY QUESTIONS PLEASE CONTACT THE LOCAL OFFICE OF THE EPA.

National Codes

This product is designed and manufactured to permit installation in accordance with National Codes. It is the installer's responsibility to install the product in accordance with National Codes and/or prevailing local codes and regulations.

SCROLL COMPRESSORS

The following should be read prior to installing units with scroll compressors.

Pump Down Procedure

Scroll equipped units should never be used to evacuate the air conditioning system. Vacuums this low can cause internal electrical arcing resulting in a damaged or failed compressor.

Crankcase Heater

Scroll equipped units do not have nor do not require a crankcase heater.

Unbrazing System Components

If the refrigerant charge is removed from a scroll equipped unit by bleeding the high side only, it is sometimes possible for the scrolls to seal, preventing pressure equalization through the compressor. This may leave the low side shell and suction line tubing pressurized. If a brazing torch is then applied to the low side while the low side shell and suction line contains pressure, the pressurized refrigerant and oil mixture could ignite when it escapes and contacts the brazing flame. To prevent this occurrence, it is important to check both the high and low side with manifold gauge before unbrazing, or in the case of repairing a unit on an assembly line, bleed refrigerant from both the high and low side.

INSTALLATION

It is not the intent of the manufacturer that this unit equipment be used with components other than indicated. An improper match voids the warranty. Reference the Specification Sheets for Performance Values and Approved System Matches.

Pre-Installation Checkpoints

Perform pre-installation checkpoints before attempting any installation. The following check points should be considered:

- Structural strength of supporting members
- Clearances and provision for servicing
- Power supply and wiring
- Air duct connections
- Drain facilities and connections

Clearance

The outdoor heat pump unit is designed to be located outside the building with unobstructed condenser air inlet and discharge. Additionally, the unit must be situated to permit

access for service and installation. Condenser air enters from three sides. Air discharges upward from the top of the unit. Refrigerant tube electrical connections are made on the right side of the unit as you face the compressor compartment. The best and most common application is for the unit to be located 10" from back wall with the connection side facing the wall. This "close to the wall" application minimizes exposed tubing and wiring and reduces the space for children to run around the unit which may cause damage to the tubes or wiring.

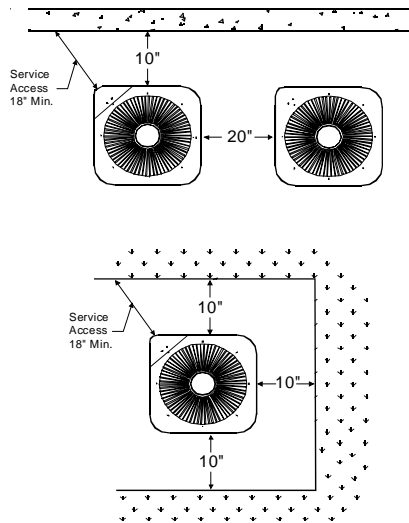

FIGURE 1

Close to the wall application assures free, unobstructed air to the other two sides. In more confined application spaces, such as corners provide a minimum 10" clearance on all air inlet sides. Allow 18" minimum for service access to the compressor compartment and controls.

The top of the unit should be completely unobstructed. If units are to be located under an overhang, there should be a minimum of 36" clearance and provisions made to deflect the warm discharge air out from the overhang.

Location

Consider the affect of outdoor fan noise on conditioned space and any adjacent occupied space. It is recommended that the unit be placed so that discharge does not blow toward windows less than 25 feet away.

The outdoor unit should be set on a solid, level foundation - preferably a concrete slab at least 4 inches thick. The slab should be above ground level and surrounded by a graveled area for good drainage. Any slab used as a unit's foundation should not adjoin the building as it is possible that sound and vibration may be transmitted to the structure. For rooftop installation, steel or treated wood beams should be used as unit support for load distribution.

Heat pumps require special location consideration in areas of heavy snow accumulation and/or areas with prolonged continuous subfreezing temperatures. Heat pump unit bases are cutout under the outdoor coil to permit drainage of frost accumulation. The unit must be situated to permit free unobstructed drainage of the defrost water and ice. A minimum 3" clearance under the outdoor coil is required in the milder climates.

In more severe weather locations, it is recommended that the unit be elevated to allow unobstructed drainage and air flow. The following elevation minimums are recommended:

Design Temperature	Suggested Minimum Elevation
+15° and above	2 1/2"
-5° to +14°	8"
below -5°	12"

Elevation Limitations

If the outdoor unit is mounted above the air handler, the maximum lift should not exceed 70' (suction line). If the air handler is mounted above the condensing unit, the lift should not exceed 50' (liquid line).

NOTE: When installing systems where the indoor - outdoor sections are separated by more than 15 feet, observe the maximum elevation separations limitations.

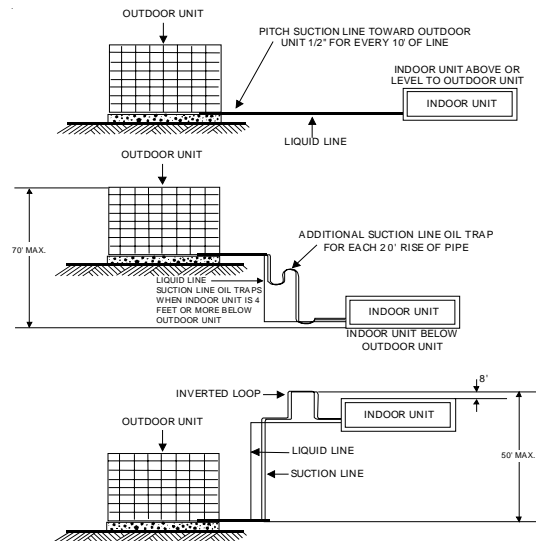

FIGURE 2

ELECTRICAL



WARNING

BEFORE ATTEMPTING ANY SERVICE OR ADJUSTMENTS - ENSURE THAT THE GAS AND ELECTRICAL SUPPLIES ARE IN THE "OFF" POSITION. FAILURE TO FOLLOW THIS WARNING MAY CAUSE PROPERTY DAMAGE, PERSONAL INJURY OR DEATH.

The supply power, voltage, frequency and phase must coincide with that on the nameplate. All wiring should be carefully checked against the manufacturer's diagrams or with the diagram on the unit's access panel. Field wiring must be connected in accordance with the National Code or other local codes that may apply. Make certain that the equipment is adequately grounded per local code requirements. Use copper wire only between disconnect and unit.

Over current protection less than that recommended on the unit's "Specification Sheet" could result in unnecessary fuse failure and service call. The manufacturer bears no responsibility for damage caused to the equipment as a result of not using the recommended size for the protective devices as listed on the unit's rating plate.

This unit has undergone a run test prior to packaging for shipment. This equipment has been started at minimum rated voltage and checked for satisfactory operation. Do not attempt to operate this unit if available voltage is not within the minimum and maximum shown on nameplate.

The condensing unit control wiring requires a 24 Volt minimum and a 40 VA service from the indoor transformer as shown on the wiring diagram.



CAUTION

BEFORE STARTING EQUIPMENT AFTER PROLONGED SHUTDOWNS OR AT THE TIME OF INITIAL START UP, BE SURE THAT THE CIRCUITS TO THE UNITS ARE CLOSED FOR AT LEAST 24 HOURS.

COMPONENTS

Contactor

This control is activated (closed) by the room T-stat for both heating and cooling. It is de-energized (open) during emergency heat. The contactor has a 24 Volt coil and supplies power to the compressor and outdoor fan motor.

Crank Case Heater

These heaters are factory wired in such a manner that they are in operation whenever the main power supply to the unit is "ON". It warms the compressor crankcase, preventing liquid migration and subsequent compressor damage. It is connected electrically to the contactor L1 and L2 terminals.

Condenser Motor

This is activated by the contactor during heating and cooling except during defrost and emergency heat operation.

Compressor

This is activated by the contactor for heating and cooling except during emergency heat. It is protected by an internal overload.

Defrost Control

This provides time/temperature initiation and termination of the defrost cycle.

Loss of Charge Protector

If the system loses refrigerant charge, the control will open to allow the compressor contactor to open.

Outdoor Thermostats

These optional controls are used to prevent full electric heater operation at varying outdoor ambient (0°F to 45°F). They are normally open above their set points and closed below to permit staging of indoor supplemental heater operation.

If the outdoor ambient temperature is below 0°F (-18°C) with 50% or higher RH, an outdoor thermostat (OT) must be installed and set at (0°) on the dial. Failure to comply with this requirement may result in damage to the product which may not be covered by the manufacturer's warranty.

Reversing Valve Coil

This is activated by the thermostat (system's switch) during cooling only and during defrost. It positions the reversing valve pilot valve for cooling operation.

PIPING

Once located, the outdoor unit is ready to be interconnected with the indoor section, using the refrigeration tubing sizes

noted in the "Long Line Application" Table. Use only refrigeration grade (dehydrated and capped) copper tubing.



CAUTION

KEEP REFRIGERATION TUBING CLEAN AND DRY PRIOR TO AND DURING INSTALLATION TO AVOID EQUIPMENT DAMAGE.

Insulation of at least 1/2" wall thickness should be used on the vapor gas line to prevent condensation when cooling and heat loss when heating. The insulation should be installed on the tubing prior to installation and should be run the entire length of the installed line. The end of the tubing over which the insulation is being slipped should be covered to insure that no foreign material is introduced to the interior of the tubing. The outdoor units are equipped with two refrigerant line service valves, and, as shipped, the valves are in the front-seated or "down" position.

Line Set Installation Instructions

Use the following instructions to install line sets:

1. Tubing should be cut square. Make sure it is round and free of burrs at the connecting ends. Clean the tubing to prevent contaminants from entering the system.
2. Wrap a wet rag around the copper valve stub before brazing.
3. Braze or silver solder the joint.
4. After brazing, quench with a wet rag to cool the joint. Evacuate and charge the connecting lines as outlined in these instructions.
5. Remove valve top cap. It is important to keep the cap in a clean area to assure proper sealing once replaced.
6. Using a standard L shaped Allen wrench, break open the valve body. To expedite opening the valve body after it is broken, use a ratchet wrench with a short Allen stub. Please note that it is normal to see oil on the valve stem body once the cap is removed.
7. Replace the valve cap and tighten with a wrench making sure that the the cap is sealed.

REFRIGERANT LINE LENGTH (Ft)						
Cond	0-24		25-49		50-74***	
Unit	Line Diameter (In. OD)					
Tons	Suct	Liq	Suct	Liq	Suct	Liq
1 1/2	5/8	1/4	3/4	3/8	3/4	3/8
2	5/8	1/4	3/4	3/8	3/4	3/8
2 1/2	3/4	3/8	3/4*	3/8	7/8	3/8
3	3/4	3/8	3/4**	3/8	7/8**	3/8
3 1/2	3/4	3/8	7/8**	3/8	1 1/8	3/8
4	7/8	3/8	1 1/8	3/8	1 1/8	3/8
5	7/8	3/8	1 1/8	3/8	1 1/8	3/8

* 7/8" required for full ratings

** 1 1/8" required for full ratings

*** Lines greater than 75' in length or changing elevation more than 50' **require additional engineering** - contact your local distributor

EVAPORATOR COIL

CAUTION

EVAPORATOR COILS ARE SHIPPED UNDER HIGH PRESSURE. USE EXTREME CARE AND FOLLOW THE INSTALLATION INSTRUCTIONS PROVIDED WITH THE EVAPORATOR COIL TO AVOID PERSONAL INJURY OR DEATH.

The indoor coil is pressurized. The copper caps must be punctured to permit a gradual escape of the pressure prior to unsweating those caps. Immediately couple the tubing to the indoor unit to avoid exposing the coils to moisture. A properly sized filter drier is furnished in the condenser. When making solder connections, make sure dry nitrogen flows through the lines, when heating the copper, to prevent oxidization inside of the copper. Hard solder (Sil-Fos) is recommended, to provide a more lasting joint.

INDOOR CFM AND HEATING CAPACITY DETERMINATION

Prior to using the methods described below to check the system's charge, it is important to verify the operating capacity of the system and that the system is delivering sufficient air across the indoor coil (CFM). The following procedures are suggested methods for determining the system's operating capacity and CFM.

Airflow Determination - Indoor Coil

The heat pump system has been designed for optimum performance with an airflow across the indoor coil equaling approximately 400 CFM/TON e.g. A 2 TON system should have 2 x 400 CFM/TON = 800 CFM. The systems airflow can be determined by several methods.

Airflow Test Instruments

There are a number of readily available instruments that can be used in the field for airflow determination such as Barometers, Volume-Aire Air Balancers, Anemometers, and Velometers. When using these devices it is important to follow the manufacture's instructions provided with them.

Temperature Rise Resistive Heat Method

Although this method is not as accurate as the use of test equipment, a method of determining the indoor airflow in a system employing electric resistance heat as the backup heat source is by the Temperature Rise Method and is calculated using the following formula:

$$CFM = \frac{KW \times 3413}{TEMPERATURE RISE \times 1.08}$$

WHERE:

KW =	The indoor section's measured input power = Volts x Amps
Volts =	The measured Volts at the Indoor Section
Amps =	The measured Amps at the Indoor Section
Temperature Rise =	The temperature of the supply air - the temperature of the return air
3413 =	BTU per KW
1.08 =	Specific Heat Air Constant

e.g. :

The input power to the indoor section = 10 KW

The Temperature Rise = 20°F

$$CFM = \frac{10 \times 3413}{20 \times 1.08} = 1580$$

Refer to the Airflow Measurement Table.

NOTE: The compressor circuit (outdoor unit) must be "OFF" to insure that the Temperature Rise measured across the indoor unit is due only to the electric heat.

Use the following instructions to determine the temperature rise across the indoor section:

1. Use the same thermometer for the measuring the return and supply air temperatures to avoid thermometer error.
2. Measure the temperatures within 6 Feet of the indoor section and downstream from any mixed air source making sure that the thermometer is not exposed to any radiant heat areas.
3. Make sure that the air temperature is stable before making measurement.

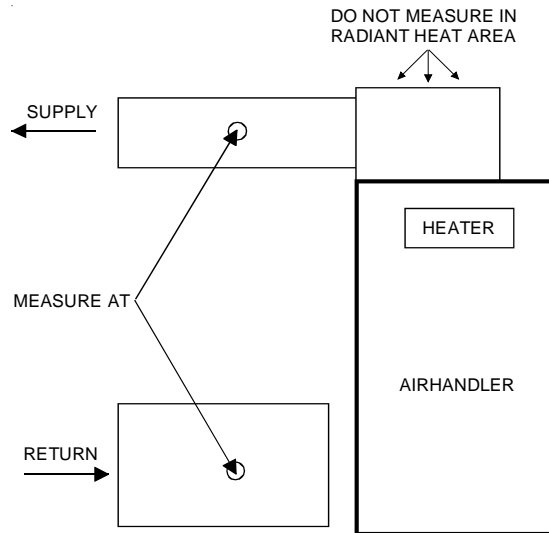

FIGURE 3

Temperature Rise Heat Pump Only Method

The Temperature Rise Resistive Heat Method can be used to determine the heating capacity of the heat pump system in the heat pump "only" mode. The results obtained using this method should agree within 10% of the data published in the Specification Sheets for the combination of indoor and outdoor section.

NOTE: When using the following procedure to determine the system's capacity, make sure that the indoor section's backup heat source is de-energized.

1. Use the same procedure described in the Temperature Rise Resistive Heat Method to determine the system's CFM and temperature rise across the indoor section.
2. Determine the BTU output of the system for the measured Temperature Rise and system CFM by using the following formula:

AIRFLOW MEASUREMENTS																							
AIRFLOW - CUBIC FEET PER MINUTE																							
HEAT OUTPUT	4	5	6	7	8	9	1	1	1	1	1	1	1	1	1	2	2	2	2	2			
	0	0	0	0	0	0	0	1	2	3	4	5	6	7	8	9	0	1	2	3	4		
	0	0	0	0	0	0	0	0	0	0	0	0	0	0	0	0	0	0	0	0	0		
KW	BTU	TEMPERATURE RISE - DEGREES FAHRENHEIT																					
3	10242	24	19	16	14	12																	
4	13656	32	25	51	18	16	14	13															
5	17070	93	32	26	23	20	18	16	14	13													
6	20484	47	38	32	27	24	21	19	17	16	15	14											
7	23898	55	44	37	32	28	25	22	20	18	17	16	15	14									
8	27312	63	51	42	36	32	28	25	23	21	19	18	17	16	15	14							
9	30726	71	57	47	41	36	32	28	26	24	22	20	19	18	17	16	15	14					
10	34140	79	63	53	45	39	35	32	29	26	24	22	21	20	19	18	17	16	15	14			
11	37554	87	69	58	50	43	39	35	32	29	27	25	23	22	20	19	18	17	16	15	14	13	
12	40968	95	76	63	54	47	42	38	34	32	29	27	25	24	22	21	20	19	18	17	16	15	14
13	44382		82	68	58	51	46	41	37	34	32	29	27	26	24	23	22	21	20	19	18	17	16
14	44796		89	74	63	55	49	44	40	37	34	32	30	28	26	25	23	22	21	20	19	18	17
15	51210		95	79	68	59	53	47	43	39	36	34	32	30	28	26	25	24	23	22	21	20	19
16	54624			84	72	64	56	50	46	42	38	36	34	32	30	28	27	25	24	23	22	21	20
17	58038			89	77	67	60	54	49	45	41	38	36	34	32	30	28	27	26	24	23	22	21
18	61452			95	82	72	64	56	52	48	44	40	38	36	34	32	30	28	27	26	25	24	23
19	64866				86	75	67	60	55	50	46	42	40	38	36	34	32	30	29	27	26	25	24
20	68280				90	79	70	63	57	53	49	45	42	40	37	35	33	32	30	29	27	26	25

BTU = CFM x TEMPERATURE x 1.08

REFRIGERANT CHARGE DETERMINATION AND ADJUSTMENT - HEAT PUMP - COOLING CYCLE

Weigh In Charge Method

The method to insure that the heat pump system is properly charged is by weighing in the amount of refrigerant specified on the outdoor sections nameplate, with additional adjustments for line size, line length, and other system components. Heat Pump units are supplied R-22 charge sufficiently for typical matching evaporator and approximately 15 Ft. of inner-connecting tubing. Systems having more than 15 ft of interconnecting refrigerant lines require an additional charge allowance of R22.

LINE O.D. (IN)	LIQUID LINE	SUCTION LINE
1/4	0.22	
3/8	0.58	
1/2	1.14	
5/8	1.86	0.04
3/4		0.06
7/8		0.08
1 1/8		0.15
1 3/8		0.22

Superheat Method

The following information has been developed to determine the proper charge for Goodman Heat Pump Systems that are already in operation.

NOTE: Many field variations exist which may affect the operating temperature and pressure readings of a heat pump system. All Goodman Heat Pump Systems utilize fixed orifice refrigerant control devices. The following procedure has been developed for this type of refrigerant control device.

1. With both base valves fully open, connect a set of service gages to the base valves' service port, being careful to purge the lines.

2. Allow the system to operate at least 10 minutes or until the pressures stabilize.
3. Temporarily install a thermometer on the suction (large) line near the condensing unit's base valve. Make sure that there is good contact between the thermometer and the refrigerant line and wrap the thermometer and line with insulating tape to assure accurate readings.
4. Determine the systems superheat as follows:
 - a. Read the system's suction pressure.
 - b. Using the Saturated Suction Pressure (R-22) Table, determine the system's saturated suction temperature.
 - c. Read the suction line temperature.
 - d. The system's superheat = the suction line temperature - the saturated liquid temperature.

SATURATED SUCTION PRESSURE (R-22)	
SUCTION PRESSURE PSIG	SATURATED SUCTION TEMPERATURE °F
50	26
53	28
55	30
58	32
61	34
63	36
66	38
69	40
72	42
75	44
78	46
81	48

5. Adjust the charge as necessary by adding charge to lower the superheat or bleeding the charge to raise the superheat.

SYSTEM SUPERHEAT					
AMBIENT CONDENSER INLET TEMPERATURE °F DB	RETURN AIR TEMPERATURE °F DB				
	65	70	75	80	85
100				5	5
95			5	7	9
90			7	12	18
85		5	10	17	20
80		5	12	21	26
75	5	10	17	25	29
70	5	14	20	28	32
65	13	19	26	32	35
60	17	25	30	33	37



CAUTION

REMOVE THE SERVICE GAUGE SET FROM THE LINES CAREFULLY. ESCAPING LIQUID REFRIGERANT CAN CAUSE BURNS.

Expansion Valve System-Subcooling Charge Method

1. Fully open both base valves.
2. Connect service gauge manifold to base-valve service parts making sure lines are purged. Run system at least 10 minutes to allow pressure to stabilize.
3. Temporarily install the thermometer to liquid (small) line near condensing unit. Be sure that the contact between thermometer and line is good. Wrap thermometer with insulating material to ensure accurate reading.
4. Referring to the Saturated Liquid Line Temperature Table,

adjust charge to obtain a temperature 12-15°F below the saturated liquid temperature.

Example:

If liquid pressure is 260 psig refer to Saturated Liquid Temperature chart, 260 psig = 120° saturated temperature. Subtract liquid line temperature obtained from thermostat connect to liquid line. The liquid line temperature must be 12° - 15° cooler than the refrigeration saturation temperature. If the liquid line temperature is warmer than 12° - 15° add charge to decrease, if the temperature of liquid line is lower than 12° - 15° recover charge from the system.

SATURATED LIQUID TEMPERATURE	
LIQUID PRESSURE (PSIG)	SATURATED TEMPERATURE °F
200	102
210	105
220	108
230	111
240	114
250	117
260	120
270	123
280	126
290	128
300	131

HEAT PUMP - HEATING CYCLE

As in the cooling mode, the proper method of insuring that the system is properly charge is by weight with the additional charge adjustments for line size, line length, and other system components as previously indicated.

Hot Gas Method

The following procedure can be employed as a method to check for system charge in the heating mode by measuring the hot discharge gas at the compressor.

1. Allow the system to operate at least 20 minutes.
2. Attach and insulate an electronic thermometer's probe to the vapor service valve (large line) at the base valve. NOTE - Make sure that the probe is well insulated from the outdoor air.
3. Allow the system to operate at least 10 minutes. Afterwards, use an accurate electronic thermometer to measure the temperature of the discharge gas at the probe.
4. Using the electronic thermostat, measure the outdoor ambient temperature.
5. For check purposes the temperature measured on the hot gas line should be equal to the outdoor ambient temperature plus 110°F (+ or - 4°F). e.g: Outdoor Ambient 45°F then the temperature measured by the thermometer's probe should be 155°F for a system that is properly charged. If the temperature measured by the thermometer's probe is higher than the outdoor ambient plus 110°F, the system charge should be adjusted by adding refrigerant to lower the temperature. If the temperature measured is lower than the outdoor ambient plus 110°F, the system charge should be adjusted by recovering charge to raise the temperature

NOTE: When adjusting the charge in this manner allow the system to operate for at least 10 minutes before taking the next temperature reading.

STARTUP PROCEDURE AND CHECK LIST



CAUTION

DISCONNECT ALL POWER TO THE UNIT. FAILURE TO FOLLOW THIS WARNING MAY RESULT IN PROPERTY DAMAGE, PERSONAL INJURY, OR DEATH DUE TO ELECTRICAL SHOCK.

1. Set first-stage thermostat heat anticipator to .12 and turn thermostat system switch to "COOL" and fan switch to "AUTO".
2. Turn cooling temperature setting as high as it will go.
3. Inspect all registers and set them to the normal open position.
4. Turn on the unit's electrical supply at the fused disconnect switch, both for the indoor unit and the outdoor unit.
5. Turn the fan switch to the "ON" position. The blower should operate 10 to 15 seconds later.
6. Turn the fan switch to the "AUTO" position. The blower should stop 90 seconds later.

NOTE: If outdoor temperature is below 55°F, proceed to step 9. Do not check out in the cooling mode.

7. Slowly lower the cooling temperature until the first mercury bulb makes contact. The compressor, indoor blower, and outdoor fan should now be running. Make sure cool air is supplied by the unit.
8. Turn system switch to "HEAT" and fan switch to "AUTO".
9. Slowly raise the heating temperature setting. After the heating first-stage mercury bulb (upper) makes contact, stop moving the lever. The compressor, indoor blower and outdoor fan should now be running. After giving the unit time to settle out, make sure heated air is being supplied by the indoor unit.
10. If the outdoor ambient is above 70°F, the compressor may trip on internal overload.
11. In the event that the outdoor ambient is too high to allow a thorough heating cycle check, postpone the test until another day when conditions are more suitable...but — DO NOT FAIL TO TEST.
12. If unit operates properly on the heating cycle, raise the heating temperature setting high enough until the heating second-stage mercury bulb (lower) makes contact.
13. Supplementary resistance heat, if installed, should now come on. Make sure it is operating correctly. If outdoor thermostats are installed, the outdoor ambient must be below the set point of these thermostats for heaters to operate. It may be necessary to jumper these thermostats to check heater operation if outdoor ambient is mild.
14. For thermostats with emergency heat switch, return to startup (Step #9). The emergency heat switch is located at the bottom of the thermostat. Move this switch to emergency heat. The heat pump will stop, the indoor blower will continue to run, all heaters will come on and the thermostat emergency heat light will come on.
15. If checking the unit on the heating cycle in the wintertime, when the outdoor coil is cold enough to actuate the defrost control, observe at least one defrost

cycle to make sure the unit defrosts properly.

16. Check to see if all supply and return air grilles are adjusted and air distribution system is balanced for the best compromise between heating and cooling.
17. Check for air leaks in the ductwork.
18. Make sure the heat pump is free of "rattles", and the tubing in the unit is free from excessive vibration. Also make sure tubes or lines are not rubbing against each other, sheet metal surfaces, or edges. If so, correct the trouble.
19. Set thermostat at the appropriate setting for cooling and heating or automatic changeover for normal use.
20. **Be sure the owner is instructed on the unit operation, filter servicing, correct thermostat operation, etc.** The foregoing "Start-up Procedure and Check List" is recommended to serve as an indication that the heat pump system will operate normally.

OPERATION - DEFROST CONTROL

Timing

When operating, the power to the circuit board is controlled by a temperature sensor which is clamped to a return bend on the outdoor coil. Timing periods of 30, 60, or 90 minutes may be selected by connecting the circuit board jumper wire to 30, 60, 90 respectively. Accumulation of time for the timing period selected starts when the sensor closes (approximately 28°F) and when the wall thermostat is calling for heat. At the end of the timing period, a defrost cycle will be initiated, provided the sensor remains closed. When the sensor opens (approximately 65°F), the defrost cycle is terminated. If the defrost cycle is not terminated due to the sensor temperature, a 10 minute override interrupts the defrost period.

Field Testing / Trouble Shooting

- A. Run unit in heat mode.
- B. Check unit for proper charge. Note: Bands of frost indicate low refrigerant charge
- C. Shut off power to unit.
- D. Disconnect outdoor fan by removing the purple lead from "DF2" on defrost control.
- E. Restart unit and allow frost to accumulate.
- F. After a few minutes of operation, the defrost thermostat should close. To verify this, check for 24 volts between "DFT" and "C" on board. If the temperature at the thermostat is less than 28°F and the thermostat is open, replace the thermostat as it is defective.
- G. When the defrost thermostat has closed, short the "test" pins on the board until the reversing valve shifts, indicating defrost. This could take up to 21 seconds depending on what timing period the board is set on. After defrost initiation, the short must instantly be removed or the defrost period will only last 2.3 seconds.
- H. After the defrost has terminated, check the defrost thermostat for 24 volts between "DFT" and "C". The reading should indicate 0 volts (open sensor).
- I. Shut off power to unit.
- J. Replace outdoor fan motor lead and turn on power.

General Explanation and Guidance

The heat pump is a relatively simple device. It operates *exactly as a Summer Air Conditioning unit* when it is on the *cooling*

cycle. Therefore, all the charts and data for service that apply to summer air conditioning apply to the heat pump when it is on the cooling cycle, and most apply on the heating cycle except that “condenser” becomes “evaporator”, “evaporator” becomes “condenser” and “cooling” becomes “heating”. When the heat pump is on the heating cycle, it is necessary to redirect the refrigerant flow through the refrigerant circuit external to the compressor. This is accomplished with a *reversing valve*. Thus, the hot discharge vapor from the compressor is directed to the inside coil (evaporator on the cooling cycle) where the heat is removed, and the vapor condenses into liquid. It then goes through a capillary tube, or expansion valve, to the outside coil (condenser on the cooling cycle) where the liquid is evaporated, and vapor goes to the compressor.

When the solenoid valve is operated either from heating to cooling or vice versa, it moves the pilot valve, thus putting suction pressure (low pressure) on one side of the piston of the reversing valve, and since discharge pressure (high pressure) is on the other side of the piston, the piston slides to the low pressure side and reverses the flow of the refrigerant in the circuit.

The following figures show a schematic of a heat pump on the cooling cycle and the heating cycle.

Heat Pump Refrigerant Circuit

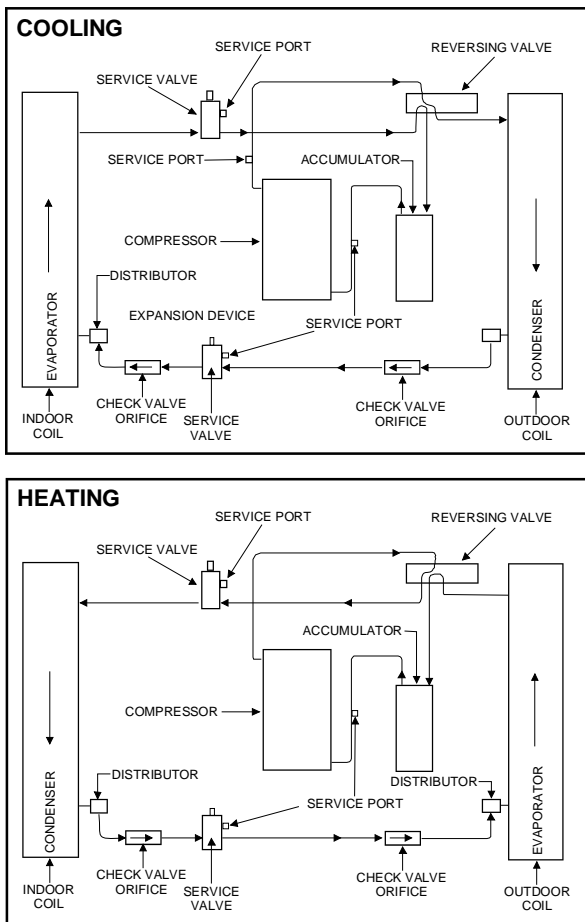

FIGURE 4

In addition to a *reversing valve*, a heat pump is equipped

with an expansion device and check valve for the inside coil, and similar equipment for the outside coil. It is also provided with a defrost control system.

The expansion device performs the same function on the heating cycle as on the cooling cycle. The check valves are required due to the reverse flow of refrigerant when changing from cooling to heating or vice versa.

When the heat pump is on the heating cycle, at which time the outdoor coil is functioning as an evaporator, the temperature of the refrigerant in the outdoor coil must be below the temperature of the outdoor air in order for the refrigerant in the outdoor coil to extract heat from the air. Thus, the greater the difference in outdoor temperature and outdoor coil temperature, the greater the heating capacity of the heat pump. Since this is characteristic of heat pumps, it is good practice to provide supplementary heat for all heat pump installations in areas where the temperature drops below 45°F. It is also good practice to provide sufficient supplementary heat to handle the entire heating requirements if there should be a failure of heat pump, such as a compressor failure, or refrigerant leak, etc.

Since the temperature of the liquid refrigerant in the outdoor coil on the heating cycle is generally below the freezing point, frost forms on the surfaces of the outdoor coil under certain weather conditions of temperature and relative humidity. Therefore, it is necessary to reverse the flow of the refrigerant to provide hot gas in the outdoor coil to melt the frost accumulation. This is accomplished by reversing the heat pump to the cooling cycle. At the same time, the outdoor fan stops to hasten the temperature rise of the outdoor coil and lessen the time required for defrosting. The indoor blower continues to run and the supplementary heaters are energized.

MAINTENANCE

General

Outdoor units do not require a planned preventative maintenance program under normal operating conditions, but not less than once each cooling season, it is recommended that the unit be inspected and, if necessary, cleaned. Particular attention should be given to the air inlet side of the outdoor coil to insure that leaves, grass, etc., are not being drawn into the unit. Restriction to air flow across the coil will result in loss of system capacity, high operating pressures and excessive operating costs. If the outdoor unit is installed adjacent to a grassy area, it is suggested that lawn mowers be routed in such a manner that the discharge of the mower will be directed away from the unit. There must be air filters installed in the system at some point upstream to the indoor coil. Air filters should be inspected and, if necessary, replaced and/or cleaned AT LEAST once a month.

If disposable filters are used, an adequate supply of clean, unused filters of the correct size should be kept available.



CAUTION

BUILD UP OF DUST AND LINT ON INTERNAL PARTS MAY CAUSE A FIRE HAZARD OR PROPERTY AND EQUIPMENT DAMAGE. NEVER OPERATE THE UNIT WITHOUT AN AIR FILTER INSTALLED IN THE RETURN AIR SYSTEM.

Permanent type filters may be vacuumed and/or washed but should not be reinstalled until thoroughly dry. Most air filters are marked to indicate the direction of airflow, and this should be carefully noted when they are being installed.



CAUTION

NEVER TURN A DIRTY FILTER TO ALLOW AIRFLOW IN THE OPPOSITE DIRECTION.

The blower and motor bearings are permanently lubricated and do not require additional lubrication.

It is recommended that the owner have available at least one set of replacement fuses of the size supplied with the original equipment.



CAUTION

DO NOT REPLACE FUSES WITH SIZES OTHER THAN THOSE SUPPLIED.

Common Causes of Unsatisfactory Operation of Heat Pumps on the Heating Cycle

- A. Dirty Filters or inadequate air volume through indoor coil. When the heat pump is on the heating cycle, the indoor coil is functioning as a condenser; therefore, the filters must always be clean, and sufficient air volume must pass through the indoor coil to prevent excessive discharge pressure and high-pressure cutout.
- B. Outside Air into Return Duct: Cold outside air should not be introduced in the return duct of a heat pump installation on the heating cycle close enough to the indoor coil to reduce temperature of the air entering the coil below 65°F. Air below this temperature will cause low discharge pressure, thus low suction pressure and excessive defrost cycling with resultant low heating output. It may also cause false defrosting.
- C. Undercharge: Undercharge on the heating cycle will cause low discharge pressure resulting in low suction pressure and frost accumulation on the lower part of the outdoor coil.
- D. Poor "Terminating" Defrost Thermostat contact. Defrost thermostat must make good thermal contact on return bend, otherwise it may not terminate the defrost cycle quickly enough to prevent unit from cutting out on high discharge pressure during the defrost cycle.
- E. Causes of Malfunctioning Reversing Valve:
 - 1. Solenoid not energized. In order to determine if the solenoid is energized, touch the nut that holds the solenoid cover in place with a screwdriver. If the nut magnetically holds the screwdriver in the Cooling mode, the solenoid is energized.
 - 2. No voltage to solenoid. Check the voltage and if there is no voltage, check the wiring circuit.
 - 3. Valve will not shift:
 - a. Undercharged: check for leaks.
 - b. Valve Body Damaged: Replace valve.
 - c. Unit Properly Charged: If it is on the heating cycle, raise discharge pressure by restricting airflow through the indoor coil. If the valve does not shift, tap it lightly on both ends with screwdriver handle.



CAUTION

DO NOT TAP THE VALVE BODY.

If the unit is on the cooling cycle, raise discharge pressure by restricting airflow through the outdoor coil. If the valve does not shift after the above attempts, cut the unit off and wait until the discharge and suction pressure equalize, and repeat above steps. If the valve still does not shift, replace it.

WIRING DIAGRAM

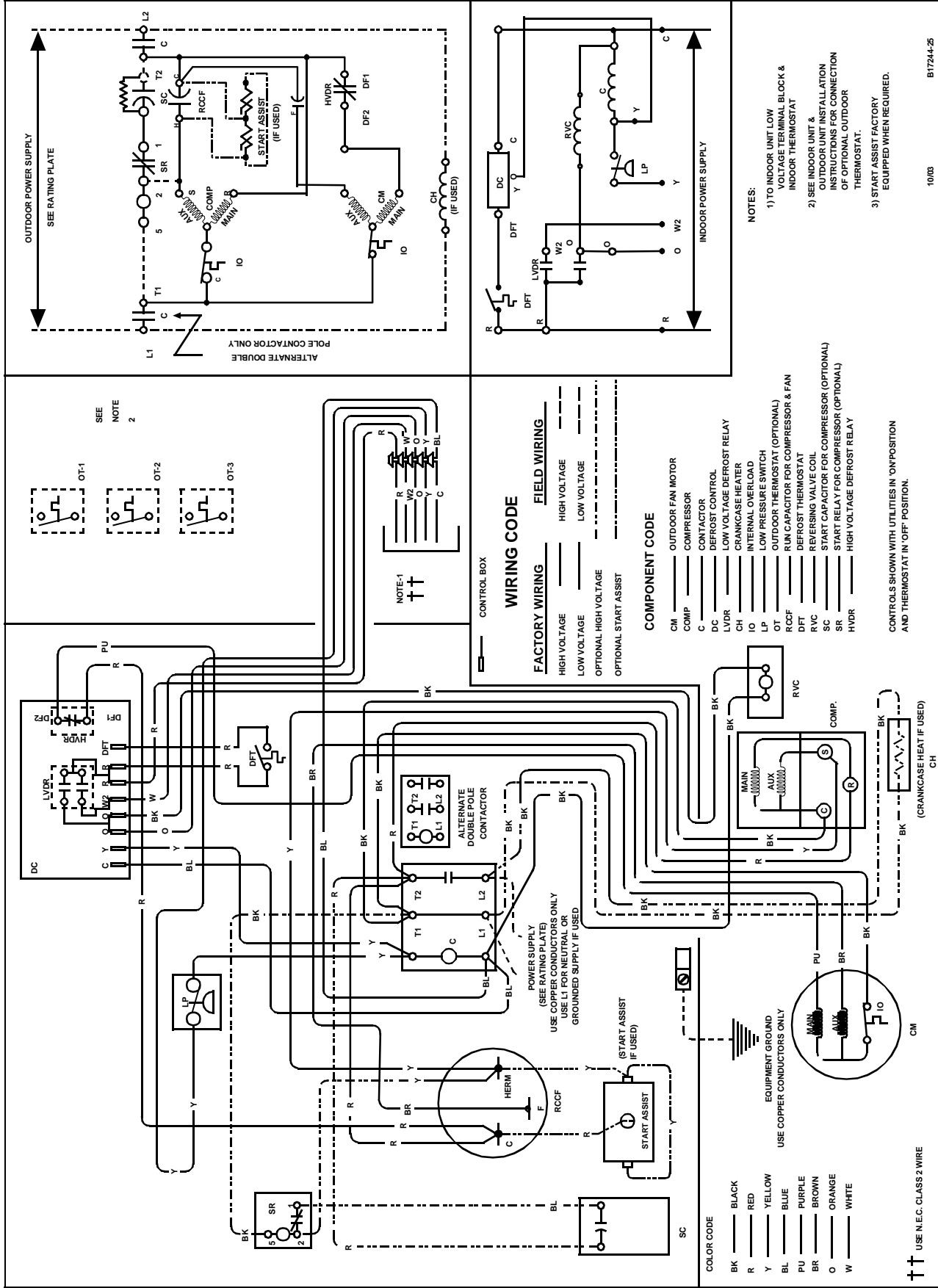

THERMOSTAT DIAGRAM

AR/ARUF/ARPF/ARPT
18-60
10 KW & BELOW

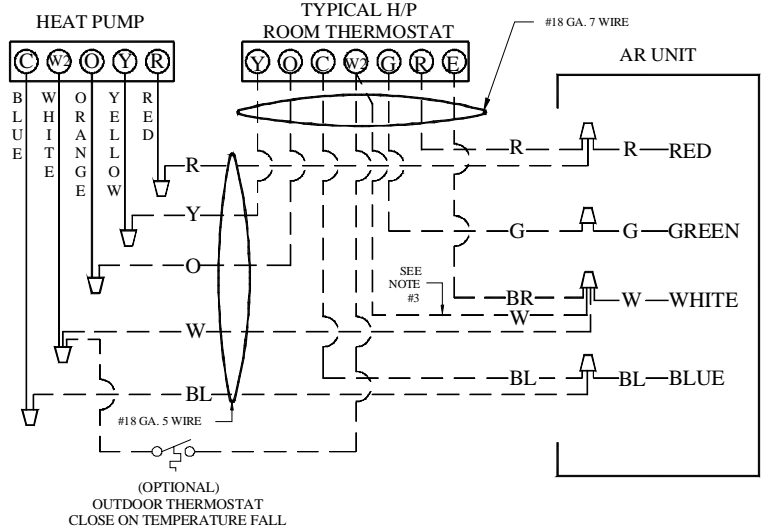

#18 GA. 6 WIRE NEEDED WHEN OT IS USED

AR/ARUF/ARPF/ARPT
18-60
ABOVE 10 KW

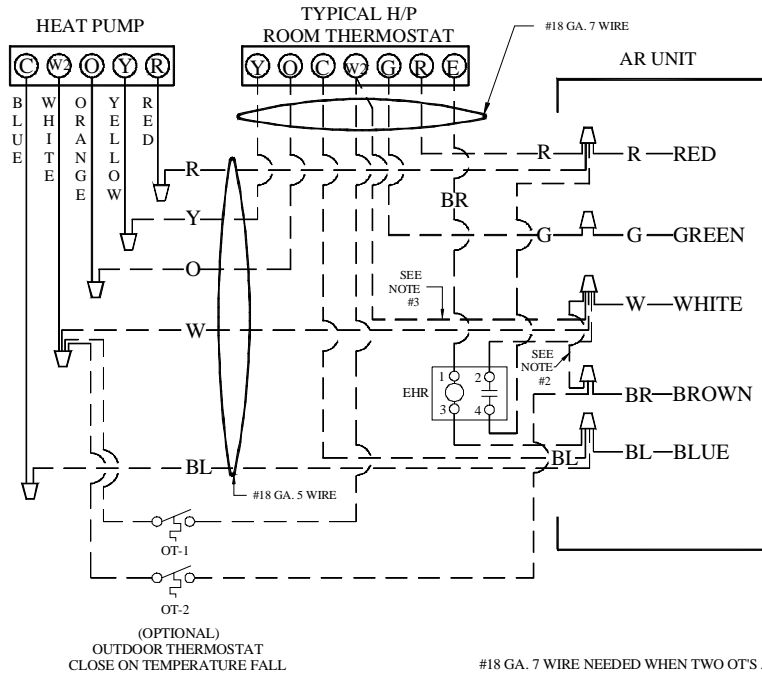

#18 GA. 7 WIRE NEEDED WHEN TWO OT'S ARE USED

NOTES:

- 1) OUTDOOR THERMOSTAT (OT-1) SHOULD BE THE FIRST TO CLOSE AND THE LAST TO OPEN.
- 2) CONNECT WHITE AND BROWN WIRES FROM AIR-HANDLER TOGETHER IF OT-2 IS NOT USED.
- 3) REMOVE WIRE WHEN USING OUTDOOR THERMOSTAT

NOMENCLATURE

- OT ---OUTDOOR THERMOSTAT (OPTIONAL)
EHR -EMERGENCY HEAT RELAY (OPTIONAL)

COLOR CODES

- R --RED
Y --YELLOW
BL-BLUE
BR-BROWN
O --ORANGE
W -WHITE
G --GREEN

**NOTE: SPECIFICATIONS AND PERFORMANCE DATA LISTED HEREIN
ARE SUBJECT TO CHANGE WITHOUT NOTICE**

Quality Makes the Difference!

All of our systems are designed and manufactured with the same high quality standards regardless of size or efficiency. We have designed these units to significantly reduce the most frequent causes of product failure. They are simple to service and forgiving to operate. We use quality materials and components. Finally, every unit is run tested before it leaves the factory. That's why we know. . .**There's No Better Quality.**

Visit our website at www.goodmanmfg.com for information on:

- Goodman products
- Warranties
- Customer Services
- Parts
- Contractor Programs and Training
- Financing Options